

Copyright

This publication, including all photographs, illustrations and software, is protected under international copyright laws, with all rights reserved. Neither this manual, nor any of the material contained herein, may be reproduced without written consent of the author.

© Copyright 2011

Disclaimer

The information in this document is subject to change without notice. The manufacturer makes no representations or warranties with respect to the contents hereof and specifically disclaims any implied warranties of merchantability or fitness for any particular purpose. The manufacturer reserves the right to revise this publication and to make changes from time to time in the content hereof without obligation of the manufacturer to notify any person of such revision or changes.

Trademark Recognition

Kensington is a U.S. registered trademark of ACCO Brand Corporation with issued registrations and pending applications in other countries throughout the world.

All other product names used in this manual are the properties of their respective owners and are acknowledged.

Important Safety Information

Important:

It is strongly recommended that you read this section carefully before using the projector. These safety and usage instructions will ensure that you enjoy many years of safe use of the projector. Keep this manual for future reference.

Symbols Used

Warning symbols are used on the unit and in this manual to alert you of hazardous situations.

The following styles are used in this manual to alert you to important information.

Note:

Provides additional information on the topic at hand.

Important:

Provides additional information that should not be overlooked.

Caution:

Alerts you to situations that may damage the unit.

Warning:

Alerts you to situations that may damage the unit, create a hazardous environment, or cause personal injury.

Throughout this manual, component parts and items in the OSD menus are denoted in bold font as in this example:

“Push the **Menu** button on the remote control to open the **Main** menu.”

General Safety Information

- Do not open the unit case. Aside from the projection lamp, there are no user-serviceable parts in the unit. For servicing, contact qualified service personnel.
- Follow all warnings and cautions in this manual and on the unit case.
- The projection lamp is extremely bright by design. To avoid damage to eyes, do not look into the lens when the lamp is on.
- Do not place the unit on an unstable surface, cart, or stand.
- Avoid using the system near water, in direct sunlight, or near a heating device.
- Do not place heavy objects such as books or bags on the unit.

Projector Installation Notice

- Place the projector in a horizontal position
The tilt angle of the projector should not exceed 15 degrees, nor should the projector be installed in any way other than the desktop and ceiling mount, otherwise lamp life could decrease dramatically.

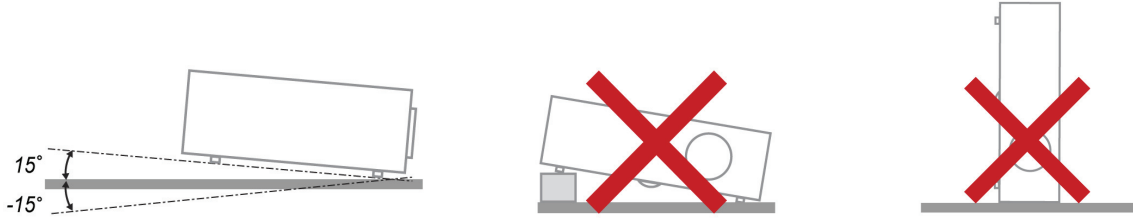

- Allow at least 50 cm clearance around the exhaust vent.

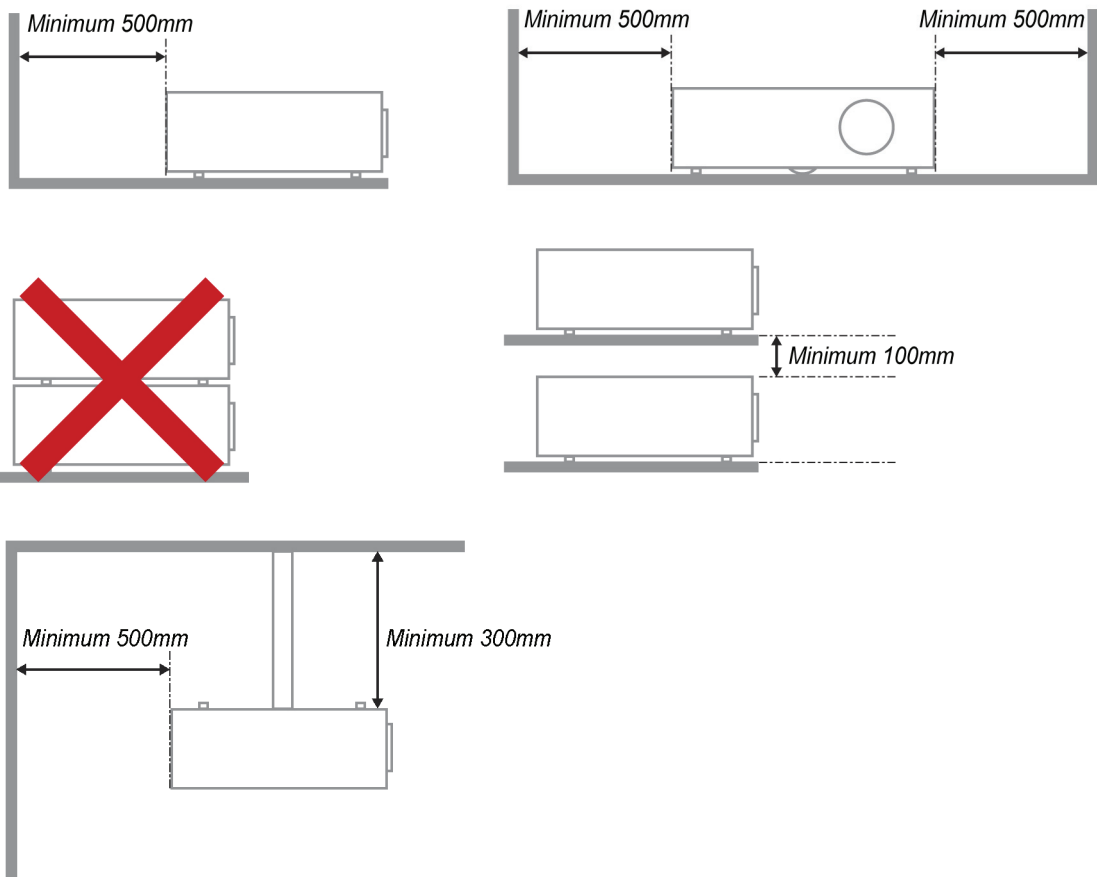

- Ensure that the intake vents do not recycle hot air from the exhaust vent.
- When operating the projector in an enclosed space, ensure that the surrounding air temperature within the enclosure does not exceed 5 – 35°C while the projector is running, and the air intake and exhaust vents are unobstructed.
- All enclosures should pass a certified thermal evaluation to ensure that the projector does not recycle exhaust air, as this may cause the device to shutdown even if the enclosure temperature is within the acceptable 5 – 35°C range.

Power Safety

- Only use the supplied power cord.
- Do not place anything on the power cord. Place the power cord where it will not be in the way of foot traffic.
- Remove the batteries from the remote control when storing or not in use for a prolonged period.

Replacing the Lamp

Replacing the lamp can be hazardous if done incorrectly. See *Replacing the Projection Lamp* on page 36 for clear and safe instructions for this procedure. Before replacing the lamp:

- Unplug the power cord.
- Allow the lamp to cool for about one hour.

Cleaning the Projector

- Unplug the power cord before cleaning. See *Cleaning the Projector* page 39.
- Allow the lamp to cool for about one hour.

Caution:

In rare cases the lamp bulb may burn out during normal operation and cause glass dust or shards to be discharged outward from the rear exhaust vent.

Do not inhale or do not touch glass dust or shards. Doing so could result in injury.

Always keep your face away from the exhaust vent so that you do not suffer from the gas and broken shards of the lamp.

Regulatory Warnings

Before installing and using the projector, read the regulatory notices in the *Regulatory Compliance* on page 51.

Important Recycle Instructions:



Lamp(s) inside this product contain mercury. This product may contain other electronic waste that can be hazardous if not disposed of properly. Recycle or dispose in accordance with local, state, or federal Laws. For more information, contact the Electronic Industries Alliance at WWW.EIAE.ORG. For lamp specific disposal information check WWW.LAMPRECYCLE.ORG.

Symbol Explanations



DISPOSAL: Do not use household or municipal waste collection services for disposal of electrical and electronic equipment. EU countries require the use of separate recycling collection services.

Main Features

- *Lightweight unit, easy to pack away and transport.*
- *Compatible with all major video standards including NTSC, PAL, and SECAM.*
- *A high brightness rating allows for presentations in daylight or in lit rooms.*
- *Supports resolutions up to UXGA at 16.7 million colors to deliver crisp, clear images.*
- *Flexible setup allows for front, rear projections.*
- *Line-of-vision projections remain square, with advanced keystone correction for angled projections.*
- *Input source automatically detected.*

About this manual

This manual is intended for end users and describes how to install and operate the DLP projector. Whenever possible, relevant information—such as an illustration and its description—has been kept on one page. This printer-friendly format is both for your convenience and to help save paper, thereby protecting the environment. It is suggested that you only print sections that are relevant to your needs.

Table of Contents

GETTING STARTED 1

- PACKING CHECKLIST 1
- VIEWS OF PROJECTOR PARTS 2
 - D5 Series Front-right View* 2
 - Top view—On-screen Display (OSD) buttons and LEDs* 3
 - Rear view* 4
 - Bottom view* 5
- REMOTE CONTROL PARTS 6
- REMOTE CONTROL OPERATING RANGE 8
- PROJECTOR AND REMOTE CONTROL BUTTONS 8

SETUP AND OPERATION 9

- INSERTING THE REMOTE CONTROL BATTERIES 9
- CONNECTING INPUT DEVICES 10
- STARTING AND SHUTTING DOWN THE PROJECTOR 11
- SETTING AN ACCESS PASSWORD (SECURITY LOCK) 13
- ADJUSTING THE PROJECTOR LEVEL 15
- ADJUSTING THE ZOOM, FOCUS AND KEYSTONE 16
- ADJUSTING THE VOLUME 17

ON-SCREEN DISPLAY (OSD) MENU SETTINGS 18

- OSD MENU CONTROLS 18
 - Navigating the OSD* 18
- SETTING THE OSD LANGUAGE 19
- OSD MENU OVERVIEW 20
- OSD SUB-MENU OVERVIEW 21
- IMAGE MENU 22
 - Advanced Feature* 23
 - Color Manager* 24
- COMPUTER MENU 25
- VIDEO/AUDIO MENU 26
 - Audio* 27
- INSTALLATION I MENU 28
 - Advanced* 29
 - Presentation Timer* 29
- INSTALLATION II MENU 30
 - 2D to 3D* 31
 - Advanced Feature* 32
 - OSD Menu Setting* 33
 - Peripheral Test* 33
 - Lamp Hour Reset* 34
 - 3D* 34
 - Factory Reset* 35
 - Status* 35

MAINTENANCE AND SECURITY 36

- REPLACING THE PROJECTION LAMP 36
 - Resetting the Lamp* 38
- CLEANING THE PROJECTOR 39
 - Cleaning the Lens* 39
 - Cleaning the Case* 39
- USING THE KENSINGTON® LOCK 40

TROUBLESHOOTING 41

- COMMON PROBLEMS AND SOLUTIONS 41
- TIPS FOR TROUBLESHOOTING 41
- LED ERROR MESSAGES 42
- IMAGE PROBLEMS 42

LAMP PROBLEMS	43
REMOTE CONTROL PROBLEMS	43
AUDIO PROBLEMS	43
HAVING THE PROJECTOR SERVICED	43
HDMI™ Q & A.....	44
SPECIFICATIONS.....	45
SPECIFICATIONS.....	45
PROJECTION DISTANCE VS. PROJECTION SIZE.....	46
<i>D5 Series Projection Distance and Size Table</i>	46
D5 SERIES TIMING MODE TABLE.....	48
PROJECTOR DIMENSIONS	50
REGULATORY COMPLIANCE	51
FCC WARNING	51
CANADA	51
SAFETY CERTIFICATIONS.....	51
APPENDIX I	52
RS-232C PROTOCOL.....	52

GETTING STARTED

Packing Checklist

Carefully unpack the projector and check that the following items are included:

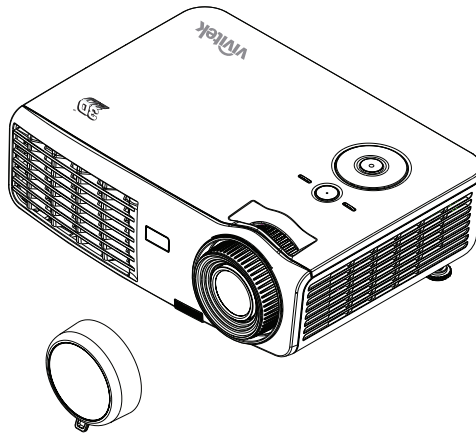

D5 SERIES DLP PROJECTOR WITH LENS CAP

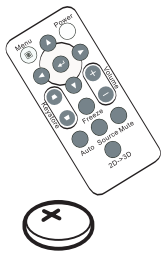

*REMOTE CONTROL
(WITH ONE 3V CR2025
BATTERY)*

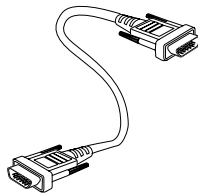

RGB CABLE

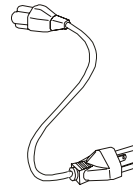

POWER CORD

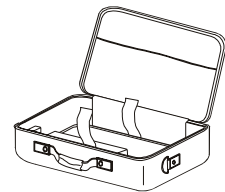

CARRYING CASE



*CD-ROM
(THIS USER'S MANUAL)*

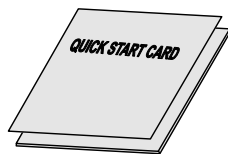

QUICK START CARD



WARRANTY CARD

Contact your dealer immediately if any items are missing, appear damaged, or if the unit does not work. It is recommended that you keep the original packing material should you ever need to return the equipment for warranty service.

Caution:
Avoid using the projector in dusty environments.

Views of Projector Parts

D5 Series Front-right View

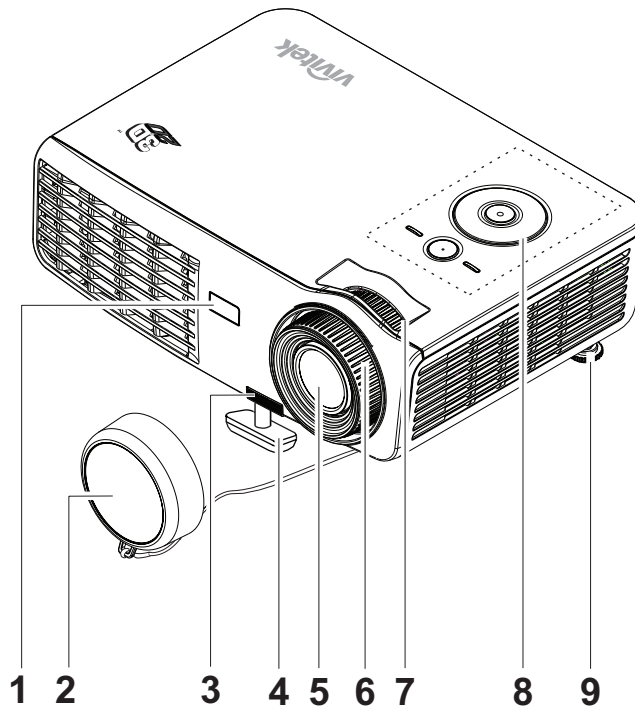

ITEM	LABEL	DESCRIPTION	SEE PAGE:
1.	IR receiver	Receive IR signal from remote control	6
2.	Lens cap	Protect lens when not in use	
3.	Height-adjuster button	Push to release height adjuster	15
4.	Height adjuster	Adjusts level of projector	
5.	Lens	Projection Lens	
6.	Focus ring	Focuses the projected image	16
7.	Zoom ring	Enlarges the projected image	
8.	Function keys	See Top view—On-screen Display (OSD) buttons and LEDs.	3
9.	Height adjuster	Adjusts level of projector	15

Important:

Ventilation openings on the projector allow for good air circulation, which keeps the projector lamp cool. Do not obstruct any of the ventilation openings.

Top view—On-screen Display (OSD) buttons and LEDs

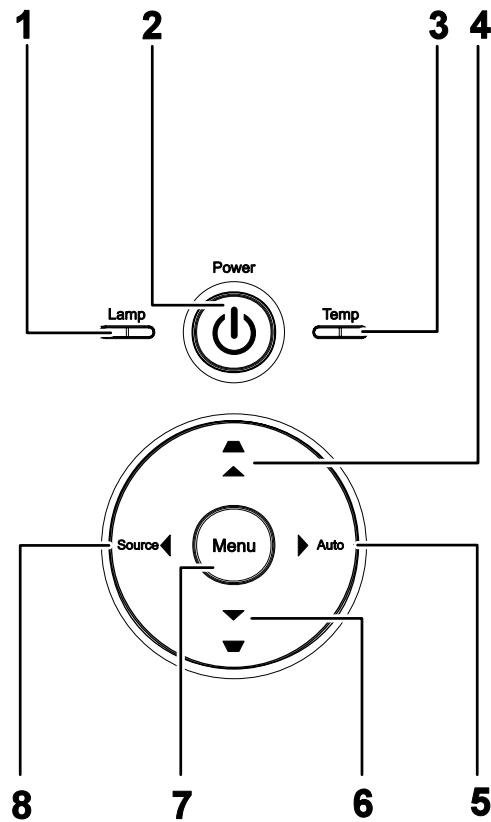

ITEM	LABEL	DESCRIPTION		SEE PAGE:
1.	LAMP LED	On	Lamp error	
		Off	Normal State	
2.	⏻ (POWER)	Turns the projector On or Off		11
3.	TEMP LED	On	System over temperature	
		Off	Normal State	
4.	▲ (Up cursor) / KEYSTONE	Navigates and changes settings in the OSD Quick Menu – For Keystone		18
5.	▶ (Right cursor) / Auto	Navigates and changes settings in the OSD Optimizes image size, position, and resolution		
6.	▼ (Down cursor) / KEYSTONE	Navigates and changes settings in the OSD Quick Menu – For Keystone		
7.	MENU	Open and exits the OSD buttons		
8.	◀ (Left cursor) / Source	Navigates and changes settings in the OSD Detects the input device		

Rear view

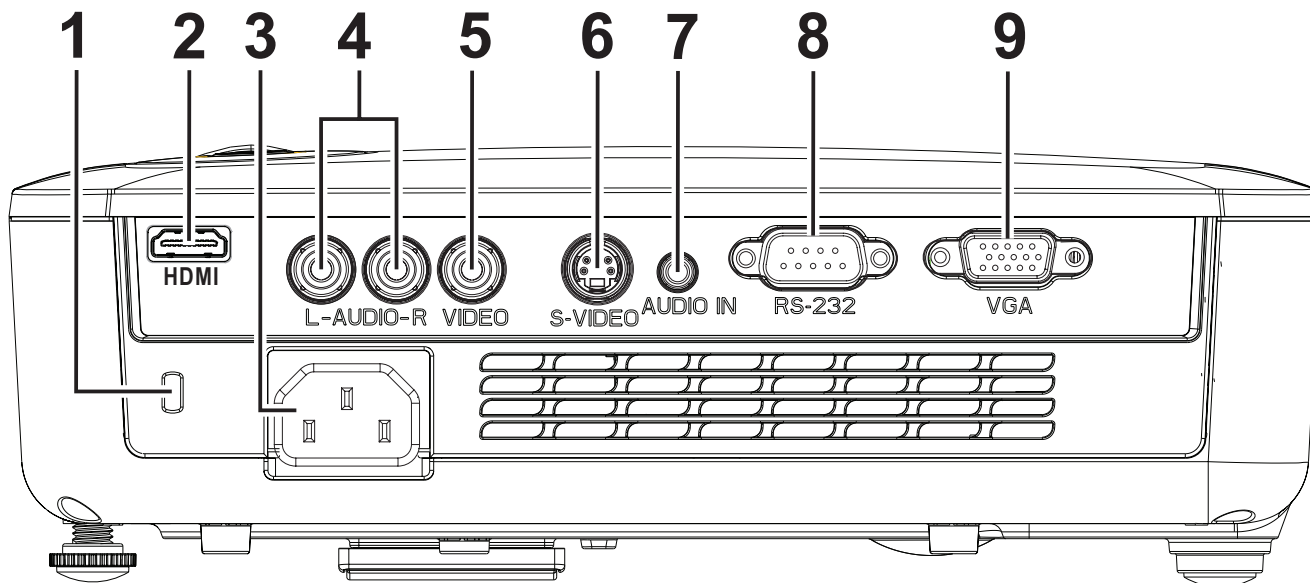

ITEM	LABEL	DESCRIPTION	SEE PAGE:
1.	Kensington Lock	Secure to permanent object with a Kensington® Lock system	40
2.	HDMI	Connect the HDMI™ CABLE from a HDMI™ device	10
3.	AC IN	Connect the POWER CABLE	11
4.	AUDIO IN (L and R)	Connect the AUDIO CABLES from a audio device	10
5.	VIDEO IN	Connect the COMPOSITE CABLE from a video device	
6.	S-VIDEO IN	Connect the S-VIDEO CABLE from a video device	
7.	AUDIO IN	Connect an AUDIO CABLE from the input device	
8.	RS-232C	Connect RS-232 serial port cable for remote control	
9.	VGA	Connect the RGB CABLE from a computer and components	

Note:

If your video equipment has both S-VIDEO and RCA jacks (composite video) connect to the S-VIDEO connector. S-VIDEO provides a better quality signal.

Bottom view

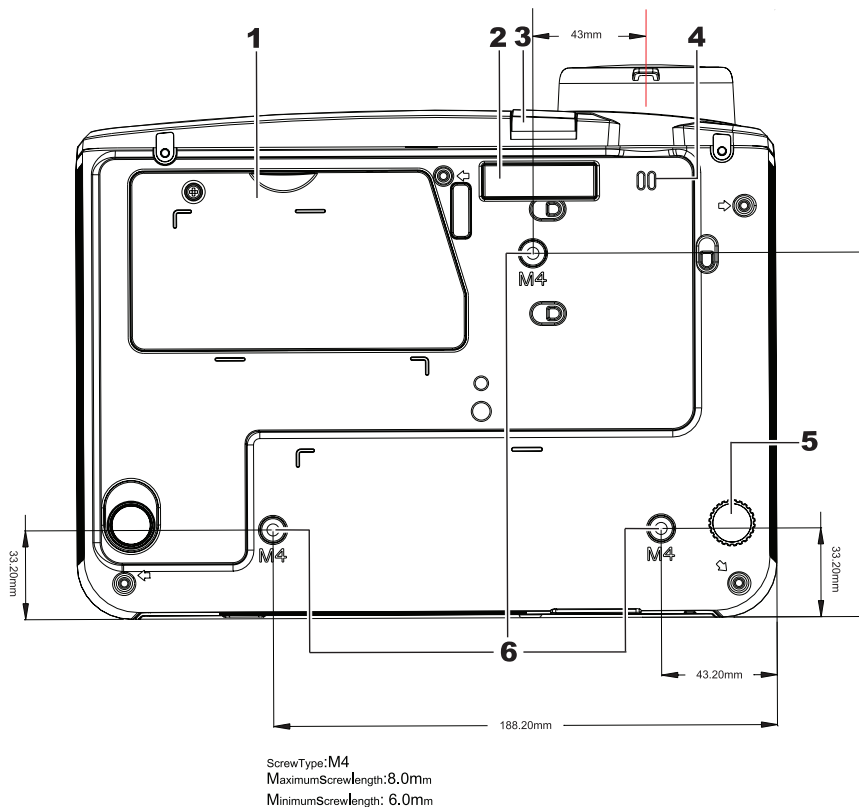

ITEM	LABEL	DESCRIPTION	SEE PAGE:
1.	Lamp cover	Remove when changing the lamp.	36
2.	Height adjuster	Adjuster drops down when adjuster button is pushed.	15
3.	Height adjuster button	Push to release adjuster.	
4.	Lens cap hook	To fasten the lens cap cover	
5.	Tilt adjuster	Rotate adjuster lever to adjust angle position.	15
6.	Ceiling support holes	Contact your dealer for information on mounting the projector on a ceiling	

Note:

When installing, ensure that you use only UL Listed ceiling mounts.

For ceiling installations, use approved mounting hardware and M4 screws with a maximum screw depth of 6 mm (0.23 inch).

The construction of the ceiling mount must be of a suitable shape and strength. The ceiling mount load capacity must exceed the weight of the installed equipment, and as an additional precaution be capable of withstanding three times the weight of the equipment (not less than 5.15 kg) over a period of 60 seconds.

Remote Control Parts

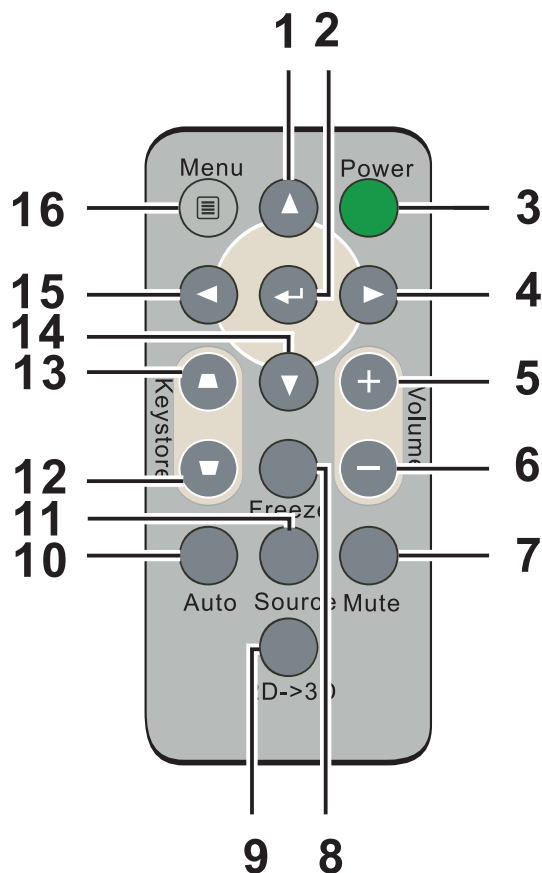

Important:

1. Avoid using the projector with bright fluorescent lighting turned on. Certain high-frequency fluorescent lights can disrupt remote control operation.
2. Be sure nothing obstructs the path between the remote control and the projector. If the path between the remote control and the projector is obstructed, you can bounce the signal off certain reflective surfaces such as projector screens.
3. The buttons and keys on the projector have the same functions as the corresponding buttons on the remote control. This user's manual describes the functions based on the remote control.

ITEM	LABEL	DESCRIPTION	SEE PAGE:
1.	Up cursor	Navigates and changes settings in the OSD	18
2.	Enter	Changes settings in the OSD	
3.	Power	Turns the projector On or Off	11
4.	Right cursor	Navigates and changes settings in the OSD	18
5.	Volume +	Increase volume	17
6.	Volume -	Decrease volume	
7.	Mute	Mutes the built-in speaker	
8.	Freeze	Freeze/unfreezes the on-screen picture	
9.	2D->3D	Toggle 2D video to 3D video via HDMI	
10.	Auto	Auto adjustment for frequency, tracking, size, position (RGB only)	
11.	Source	Detects the input device	10
12.	Keystone top	Corrects image-trapezoid (wider top) effect	16
13.	Keystone bottom	Corrects image trapezoid (wider bottom) effect	
14.	Down cursor	Navigates and changes settings in the OSD	18
15.	Left cursor	Navigates and changes settings in the OSD	
16.	Menu	Opens the OSD	

Remote Control Operating Range

The remote control uses infrared transmission to control the projector. It is not necessary to point the remote directly at the projector. Provided you are not holding the remote perpendicular to the sides or the rear of the projector, the remote will function well within a radius of about 7 meters (23 feet) and 15 degrees above or below the projector level. If the projector does not respond to the remote control, move a little closer.

Projector and Remote Control Buttons

The projector can be operated using the remote control or the buttons on the top of the projector. All operations can be carried out with the remote control; however, the buttons on the projector are limited in use.

SETUP AND OPERATION

Inserting the Remote Control Batteries

1. Remove the battery compartment cover by sliding the cover in the direction of the arrow (A). Pull out the cover (B).

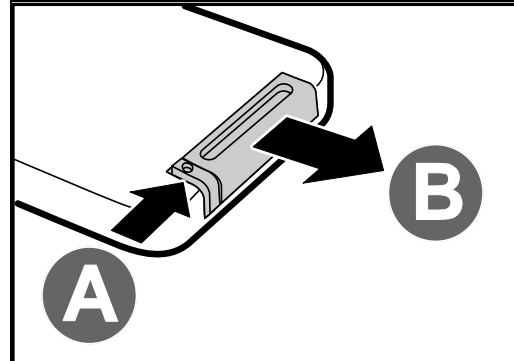

2. Insert the battery with the positive side facing up.

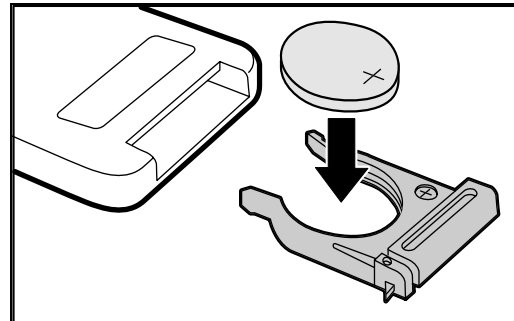

3. Replace the cover.

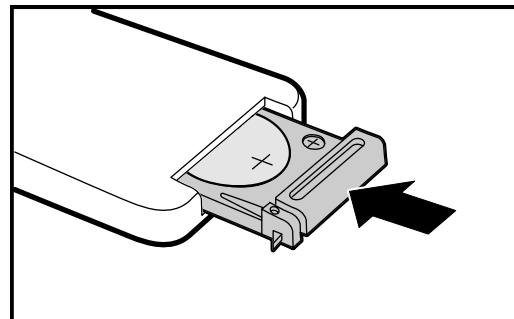

Caution:

1. Only use a 3V lithium battery (CR2025).
2. Dispose of used batteries according to local ordinance regulations.
3. Remove the battery when not using the projector for prolonged periods.

Connecting Input Devices

A PC or notebook computer and video devices can be connected to the projector at the same time. Video devices include DVD, VCD, and VHS players, as well as movie camcorders and digital still cameras. Check the user manual of the connecting device to confirm it has the appropriate output connector.

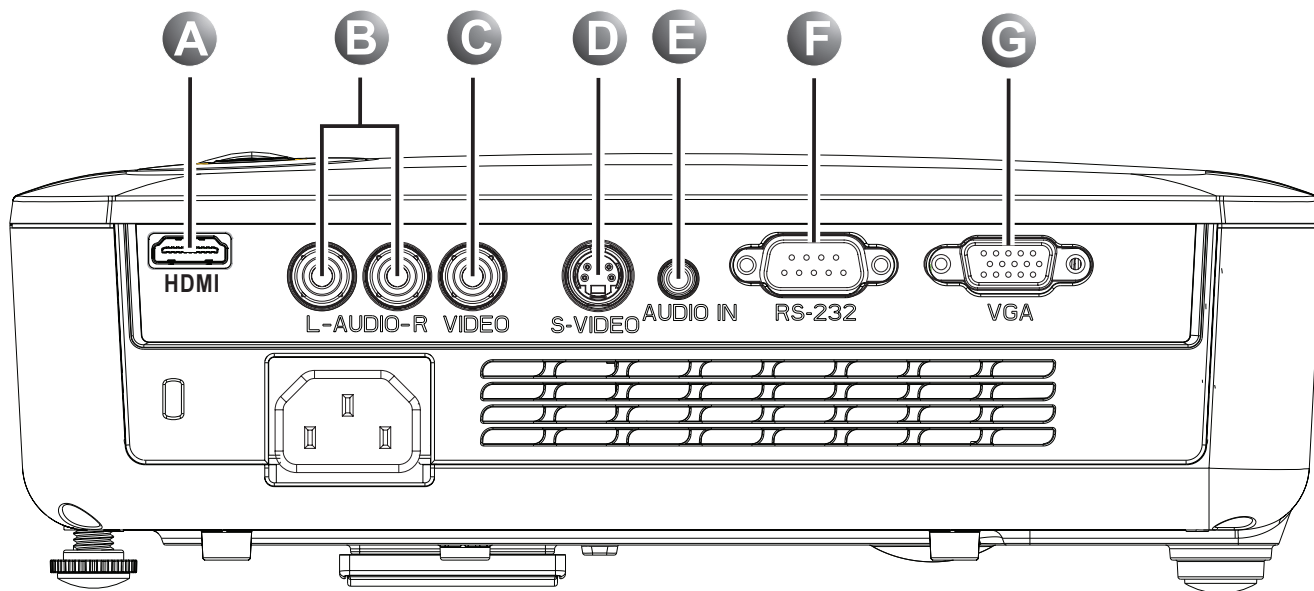

ITEM	LABEL	DESCRIPTION
A	HDMI	Connect the HDMI™ CABLE from a HDMI™ device
B	AUDIO IN (L and R)	Connect the AUDIO CABLES from a audio device
C	VIDEO IN	Connect the COMPOSITE CABLE from a video device
D	S-VIDEO	Connect the S-VIDEO CABLE from a video device
E	AUDIO IN	Connect an AUDIO CABLE from the input device
F	RS-232C	Connect the RS-232 serial cable for remote control
G	VGA IN	Connect the RGB CABLE from a computer and components

Warning:

As a safety precaution, disconnect all power to the projector and connecting devices before making connections.

Starting and Shutting down the Projector

1. Connect the power cord to the projector. Connect the other end to a wall outlet. The **POWER** LED on the projector light.

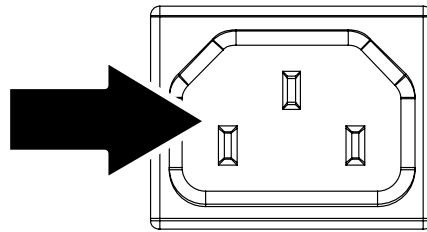

2. Turn on the connected devices.

3. Ensure the LAMP LED not a flashing orange. Then press the **POWER** button to turn on the projector.

The projector splash screen displays and connected devices are detected.

See *Setting an Access Password (Security Lock)* on page 13 if security lock is enabled.



4. If more than one input device is connected, press the **SOURCE** button and use **▲▼** to scroll among devices. (Component is supported through the RGB to COMPONENT ADAPTER.)

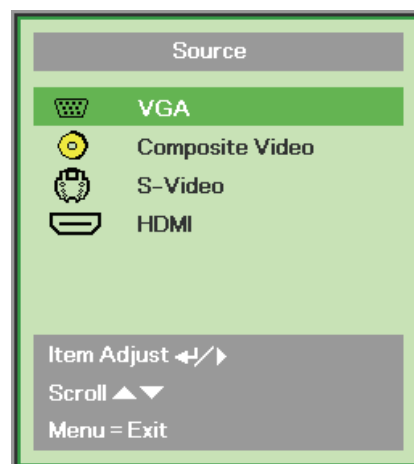

- VGA: Analog RGB
Component: DVD input YCbCr / YPbPr, or HDTV input YPbPr
- Composite Video: Traditional composite video
- S-Video: Super video (Y/C separated)
- HDMI: HDMI

- 5.** When the “Power Off? /Press **Power** again” message appears, press the **POWER** button. The projector turns off.

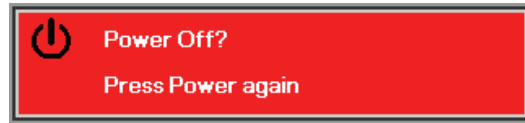

Caution:

1. *Be sure to remove the lens cap before starting projector.*
2. *Do not unplug the power cord until the LAMP LED stops flashing—indicating the projector has cooled down.*

Setting an Access Password (Security Lock)

You can use the four (arrow) buttons to set a password and prevent unauthorized use of the projector. When enabled, the password must be entered after you power on the projector. (See *Navigating the OSD* on page 18 and *Setting the OSD Language* on page 19 for help on using OSD menus.)

Important:

Keep the password in a safe place. Without the password, you will not be able to use the projector. If you lose the password, contact your reseller for information on clearing the password.

1. Press the **MENU** button to open the OSD menu.
2. Press the cursor ◀▶ button to move to the **Installation I** menu, press the cursor ▲▼ button to select **Advanced**.

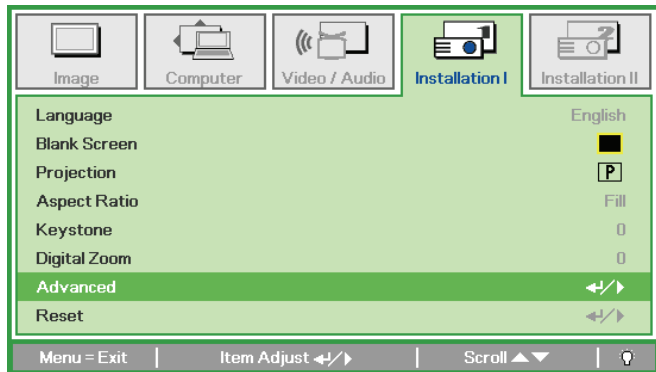
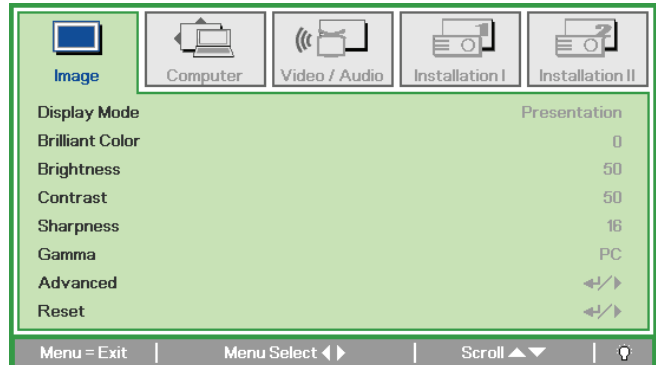

3. Press the cursor ▲▼ button to select **Security Lock**.
4. Press the cursor ◀▶ button to enable or disable security lock function.

A password dialog box automatically appears.

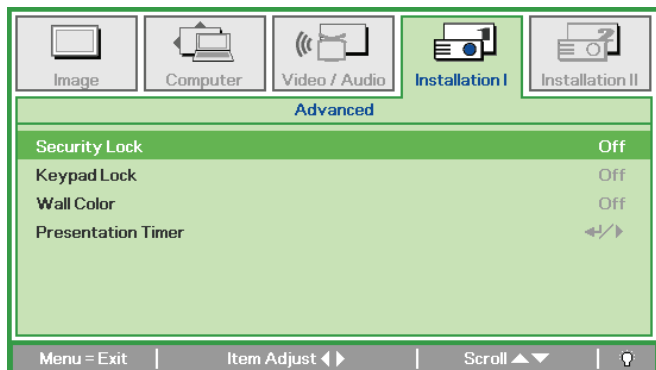

5. You can use the cursor buttons ▲▼◀▶ either on keypad or IR remote control for password entry. You can use any combination including the same arrow five times, but not less than five.

Press the cursor buttons in any order to set the password. Push the **MENU** button to exit the dialog box.

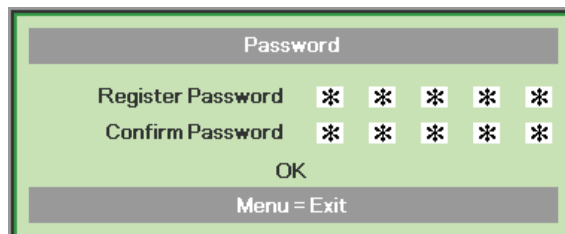
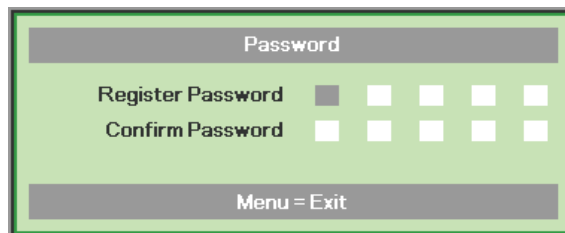

6. The password confirm menu appears when user presses the power-on key in case the **Security Lock** is enabled. Enter the password in the order you set it at step 5. In case you forget the password, please contact the service center. Service center will validate the owner and help reset the password.

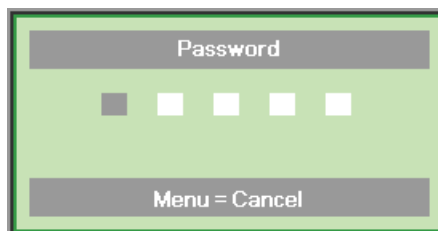

Adjusting the Projector Level

Take note of the following when setting up the projector:

- *The projector table or stand should be level and sturdy.*
- *Position the projector so that it is perpendicular to the screen.*
- *Ensure the cables are in a safe location. You could trip over them.*

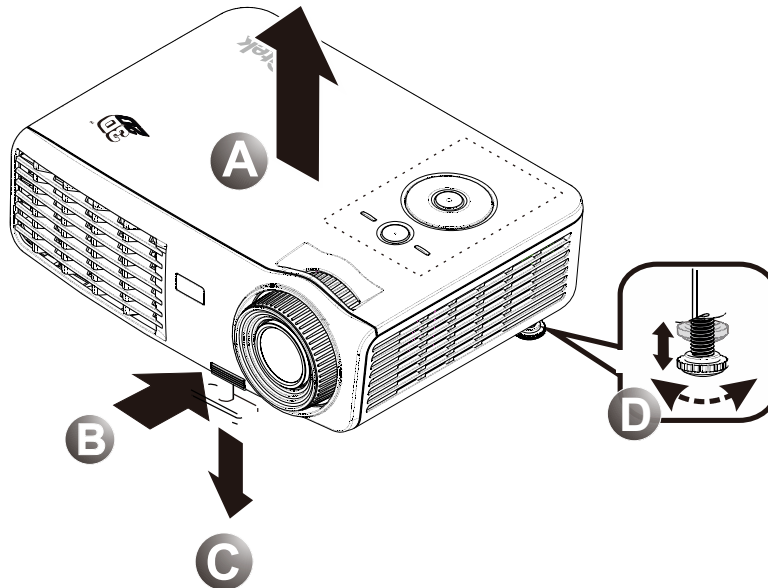

- 1.** To raise the level of the projector, lift the projector [A] and press the height-adjuster button [B].

The height adjuster drops down [C].
- 2.** To lower the level of the projector, press the height-adjuster button and push down on the top of the projector.
- 3.** To adjust the angle of the picture, turn the tilt-adjuster [D] right or left until the desired angle has been achieved.

Adjusting the Zoom, Focus and Keystone

1. Use the **Image-zoom** control (on the projector only) to resize the projected image and screen size **B**.

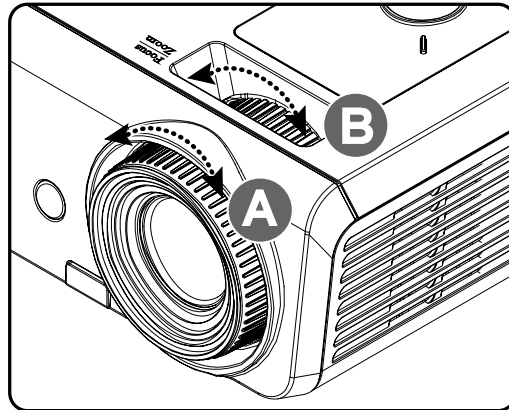

2. Use the **Image-focus** control (on the projector only) to sharpen the projected image **A**.

3. Use the **KEYSTONE** buttons (on the projector or the remote control) to correct image-trapezoid (wider top or bottom) effect.

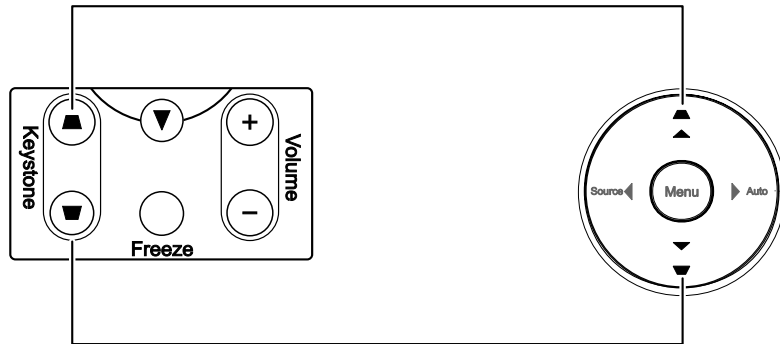

Remote control and OSD panel

4. The keystone control appears on the display.



Adjusting the Volume

1. Press the **Volume +/-** buttons on the remote control.
The volume control appears on the display.

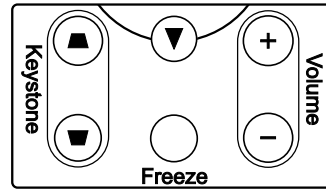

2. Press the **Left or Right Cursor** buttons on the keypad to adjust **Volume +/-**.



3. Press the **MUTE** button to turn off the volume (This feature is available only on the remote).



ON-SCREEN DISPLAY (OSD) MENU SETTINGS

OSD Menu Controls

The projector has an OSD that lets you make image adjustments and change various settings.

Navigating the OSD

You can use the remote control cursor buttons or the buttons on the top of the projector to navigate and make changes to the OSD.

1. To enter the OSD, press the **MENU** button.
2. There are five menus. Press the cursor ◀▶ button to move through the menus.
3. Press the cursor ▲▼ button to move up and down in a menu.
4. Press ◀▶ to change values for settings.
5. Press **MENU** to close the OSD or leave a submenu.

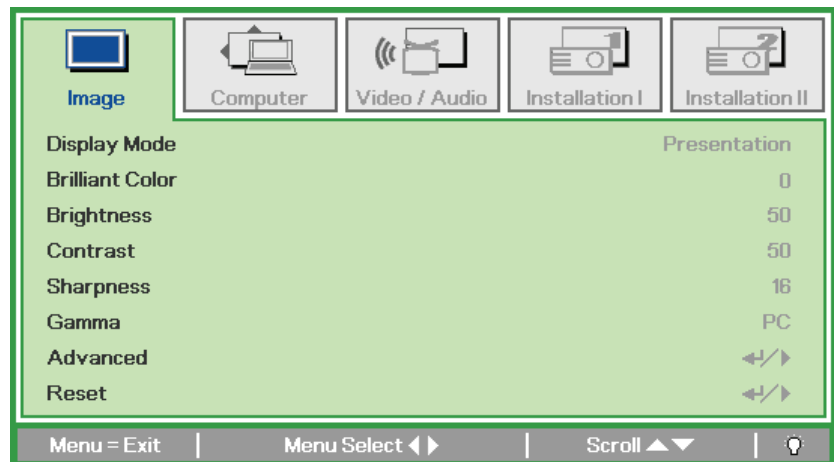

Note:

Depending on the video source, not all items in the OSD are available. For example, the **Horizontal/Vertical Position** items in the **Computer** menu can only be modified when connected to a PC. Items that are not available cannot be accessed and are grayed out.

Setting the OSD Language

Set the OSD language to your preference before continuing.

1. Press the **MENU** button. Press the cursor ◀▶ button to navigate to Installation I.

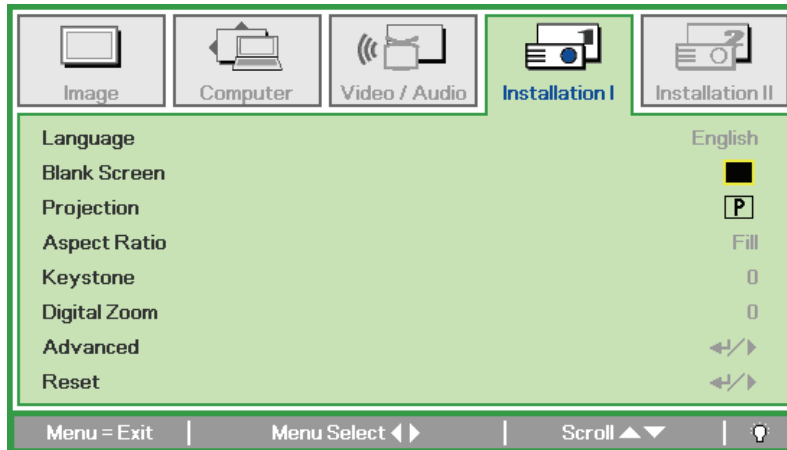

2. Press the cursor ▲▼ button until **Language** is highlighted.

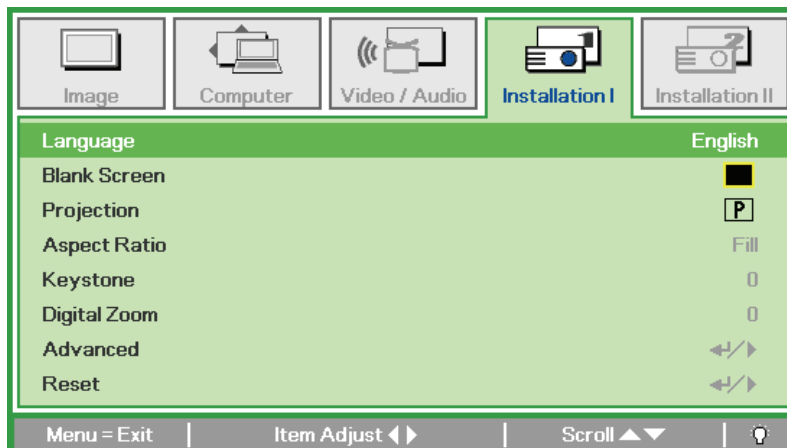

3. Press the cursor ◀▶ button until the language you want is highlighted.
4. Press the **MENU** button twice to close the OSD.

OSD Menu Overview

Use the following illustration to quickly find a setting or determine the range for a setting.

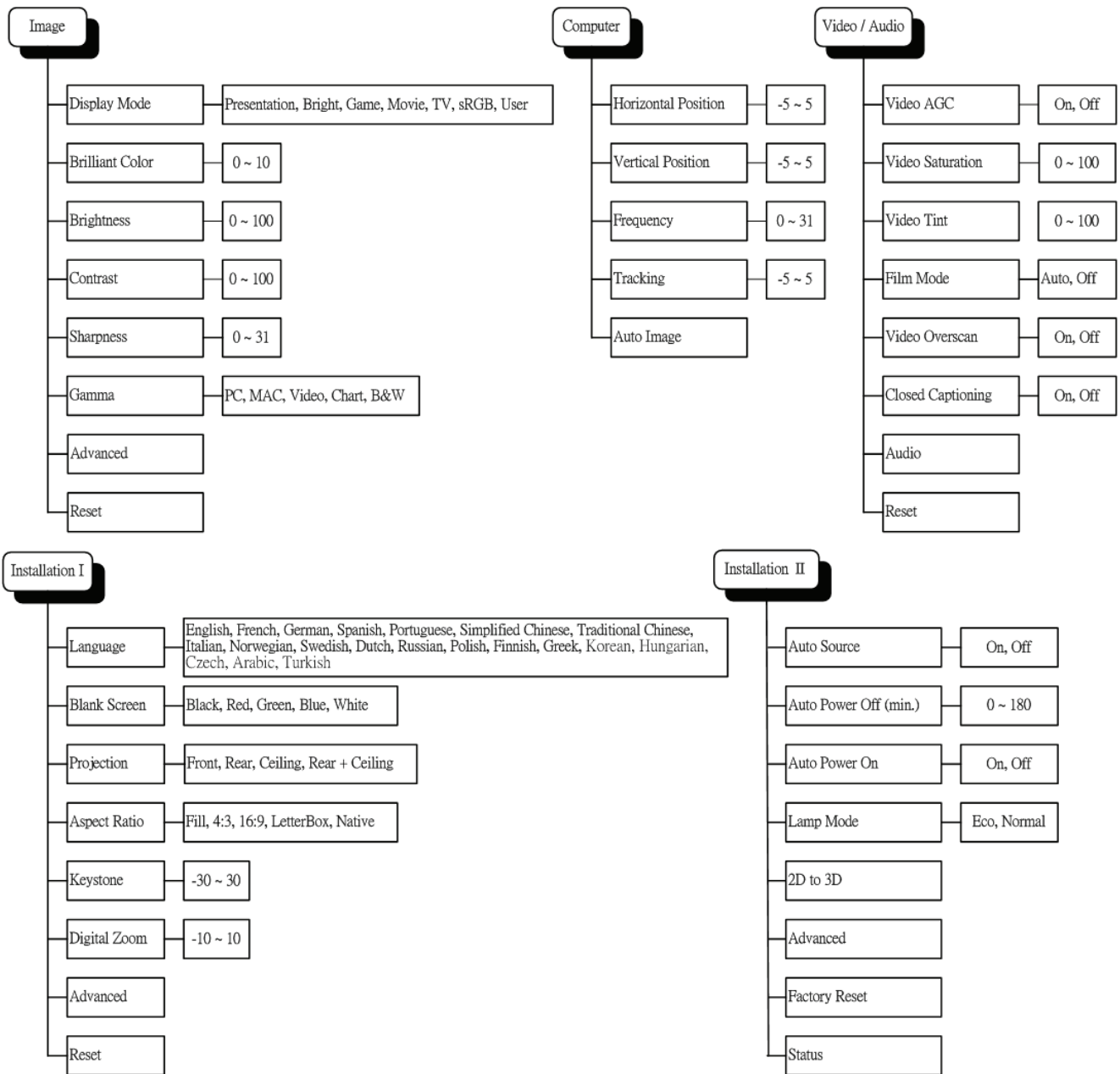

OSD Sub-Menu Overview

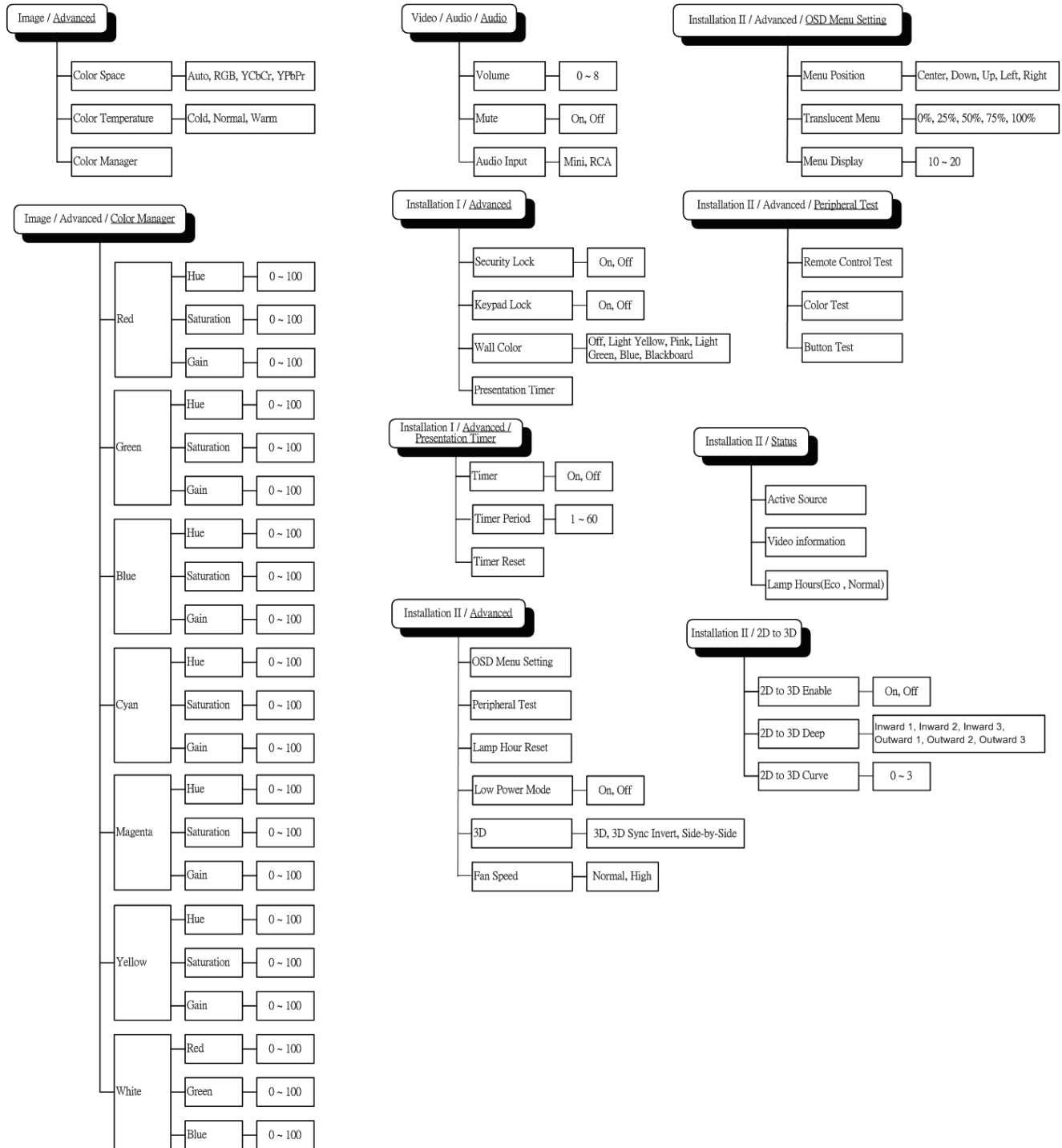
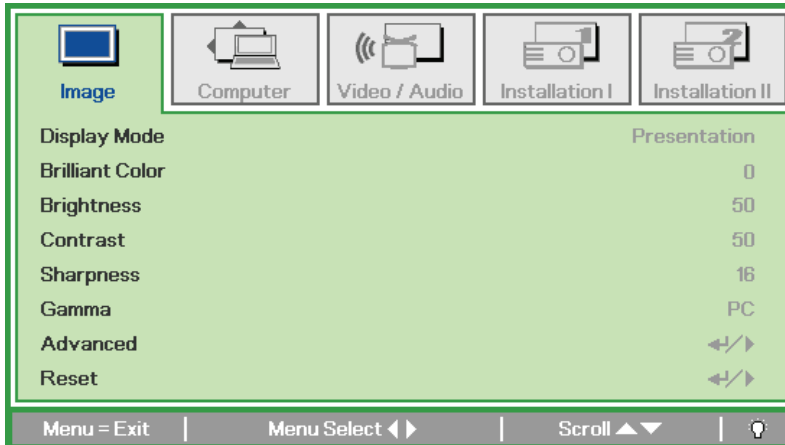

Image Menu

Press the **MENU** button to open the **OSD** menu. Press the cursor **◀▶** button to move to the **Image Menu**. Press the cursor **▲▼** button to move up and down in the **Image** menu. Press **◀▶** to change values for settings.



ITEM	DESCRIPTION
Display Mode	Press the cursor ◀▶ button to set the Display Mode.
Brilliant Color	Press the cursor ◀▶ button to adjust the Brilliant Color value.
Brightness	Press the cursor ◀▶ button to adjust the display brightness.
Contrast	Press the cursor ◀▶ button to adjust the display contrast.
Sharpness	Press the cursor ◀▶ button to adjust the display sharpness level.
Gamma	Press the cursor ◀▶ button to adjust the gamma correction of the display.
Advanced	Press ◀ (Enter) / ▶ to enter the Advanced menu. See <i>Advanced Feature</i> on page 23.
Reset	Press ◀ (Enter) / ▶ to reset all settings to default values.

Advanced Feature

Press the **Menu** button to open the **OSD** menu. Press ◀▶ to move to the **Image** menu. Press ▼▲ to move to the **Advanced** menu and then press **Enter** or ▶. Press ▼▲ to move up and down in the **Advanced** menu.

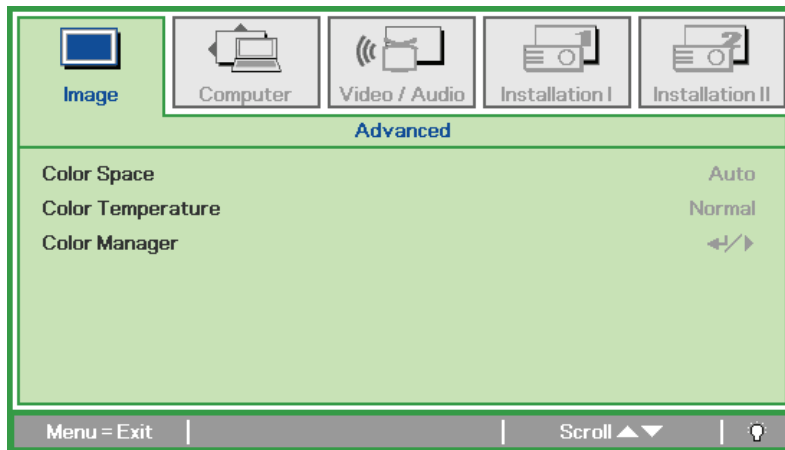

ITEM	DESCRIPTION
Color Space	Press the cursor ◀▶ button to adjust the color space.
Color Temperature	Press the cursor ◀▶ button to adjust the color temperature.
Color Manager	Press ◀ (Enter) / ▶ to enter the color manager menu. See page 24 for more information on <i>Color Manager</i> .

Color Manager

Press ◀ (Enter) / ▶ to enter the **Color Manager** sub menu.

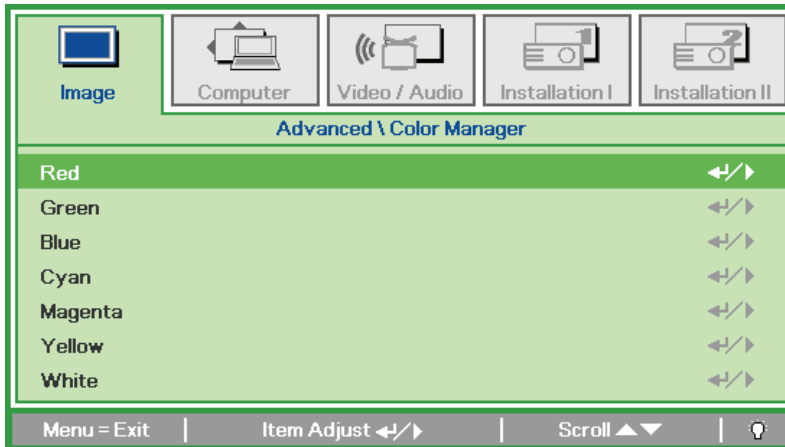

ITEM	DESCRIPTION
Red	Select to enter the Red Color Manager. Press the ◀▶ buttons to adjust the Hue, Saturation, and Gain.
Green	Select to enter the Green Color Manager. Press the ◀▶ buttons to adjust the Hue, Saturation, and Gain.
Blue	Select to enter the Blue Color Manager. Press the ◀▶ buttons to adjust the Hue, Saturation, and Gain.
Cyan	Select to enter the Cyan Color Manager. Press the ◀▶ buttons to adjust the Hue, Saturation, and Gain.
Magenta	Select to enter the Magenta Color Manager. Press the ◀▶ buttons to adjust the Hue, Saturation, and Gain.
Yellow	Select to enter the Yellow Color Manager. Press the ◀▶ buttons to adjust the Hue, Saturation, and Gain.
White	Select to enter the White Color Manager. Press the ◀▶ buttons to adjust the Red, Green, and Blue.

Computer Menu

Press the **MENU** button to open the **OSD** menu. Press the cursor ◀▶ button to move to the **Computer** menu. Press the cursor ▲▼ button to move up and down in the computer menu. Press ◀▶ to change values for settings.

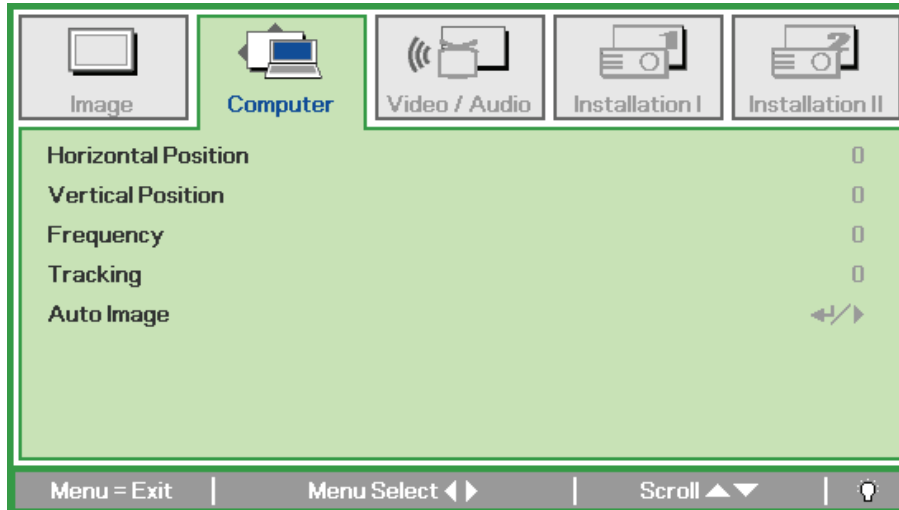

ITEM	DESCRIPTION
Horizontal Position	Press the cursor ◀▶ button to adjust the display position to left or right.
Vertical Position	Press the cursor ◀▶ button to adjust the display position to up or down.
Frequency	Press the cursor ◀▶ button to adjust the A/D sampling clock.
Tracking	Press the cursor ◀▶ button to adjust the A/D sampling dot.
Auto Image	Press ◀ (Enter) / ▶ to automatically adjustment for phase, tracking, size and position.

Video/Audio Menu

Press the **MENU** button to open the **OSD** menu. Press the cursor ◀▶ button to move to the **Video/Audio** menu. Press the cursor ▲▼ button to move up and down in the **Video/Audio** menu. Press ◀▶ to change values for settings.

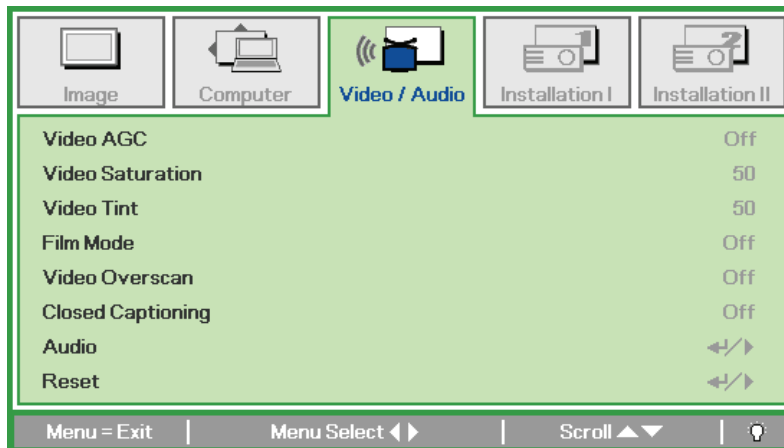

ITEM	DESCRIPTION
Video AGC	Press the ◀▶ buttons to enable or disable the Automatic Gain Control for video source.
Video Saturation	Press the ◀▶ buttons to adjust the video saturation.
Video Tint	Press the ◀▶ buttons to adjust the video tint/hue.
Film Mode	Press the ◀▶ buttons to select a different film mode.
Video Overscan	Press the ◀▶ buttons to enable or disable video over scan.
Closed Captioning	Press the ◀▶ buttons to enable or disable Closed Captioning
Audio	Press ⏏ (Enter) / ▶ to enter the Audio menu. See <i>Audio</i> on page 27.
Reset	Press ⏏ (Enter) / ▶ to reset all settings to default values.

Note:

Video jaggging may occur when playing interlace video. To overcome this issue, open the Video / Audio menu and adjust the Film Mode feature.

Audio

Press ◀ (Enter) / ▶ to enter the **Audio** sub menu.

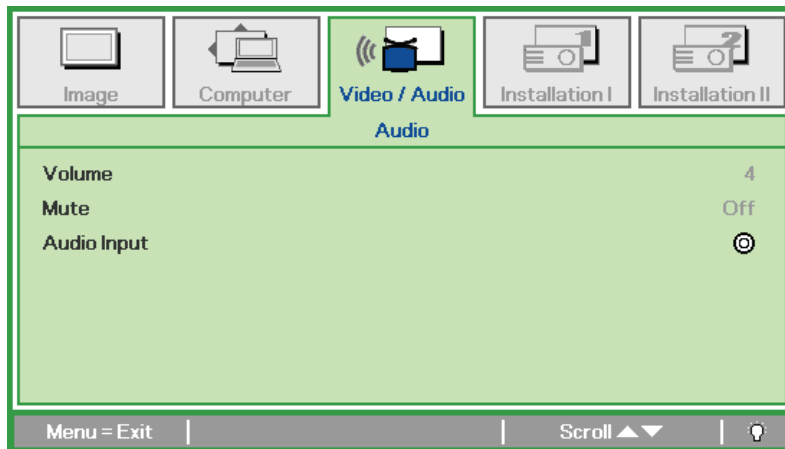

ITEM	DESCRIPTION
Volume	Press the ◀▶ buttons to adjust the audio volume.
Mute	Press the ◀▶ buttons to turn on or off the speaker.
Audio Input	Press the cursor ◀▶ button to select audio input.

Installation I Menu

Press the **MENU** button to open the **OSD** menu. Press the cursor ◀▶ button to move to the **Installation I** menu. Press the cursor ▲▼ button to move up and down in the **Installation I** menu. Press ◀▶ to change values for settings.

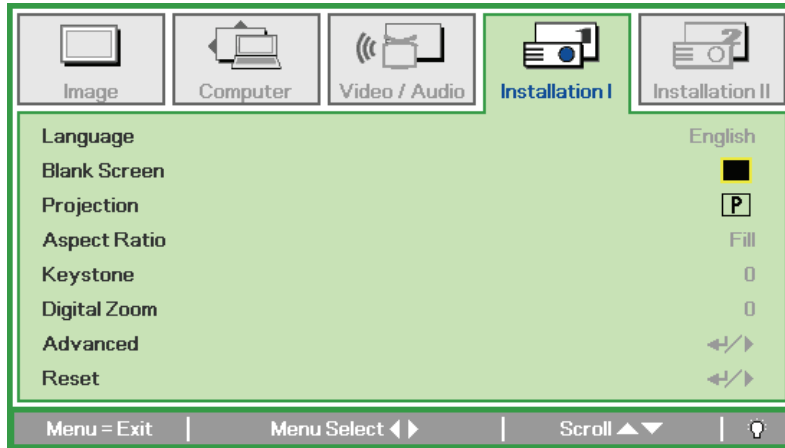

ITEM	DESCRIPTION
Language	Press the cursor ◀▶ button to select a different localization Menu.
Blank Screen	Press the cursor ◀▶ button to select different color to blank the screen.
Projection	Press the cursor ◀▶ button to choose from four projection methods:
Aspect Ratio	Press the cursor ◀▶ button to adjust the video aspect ratio.
Keystone	Press the cursor ◀▶ button to adjust the display keystone.
Digital Zoom	Press the cursor ◀▶ button to adjust the Digital Zoom menu.
Advanced	Press ◀↵ (Enter) / ▶ to enter the Advanced menu. See <i>Advanced</i> on page 29.
Reset	Press ◀↵ (Enter) / ▶ to reset all settings to default values (except Language and Security Lock).

Advanced

Press ◀ (Enter) / ▶ to enter the **Advanced** sub menu.

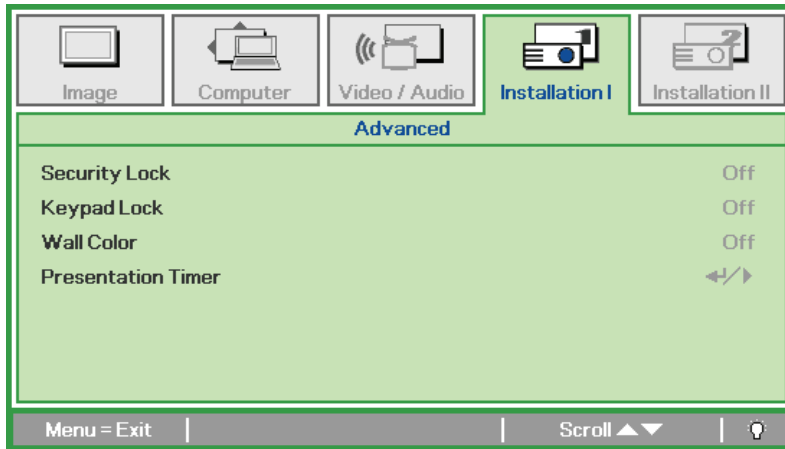

ITEM	DESCRIPTION
Security Lock	Press the cursor ◀▶ button to enable or disable security lock function.
Keypad Lock	Press the cursor ◀▶ button to enable or disable keypad lock function.
Wall Color	Press the cursor ◀▶ button to select different wall color setting.
Presentation Timer	Press ◀ (Enter) / ▶ to enter the Presentation menu. See <i>Presentation Timerr</i> on page 29.

Presentation Timer

Press ◀ (Enter) / ▶ to enter the **Presentation Timer** sub menu.

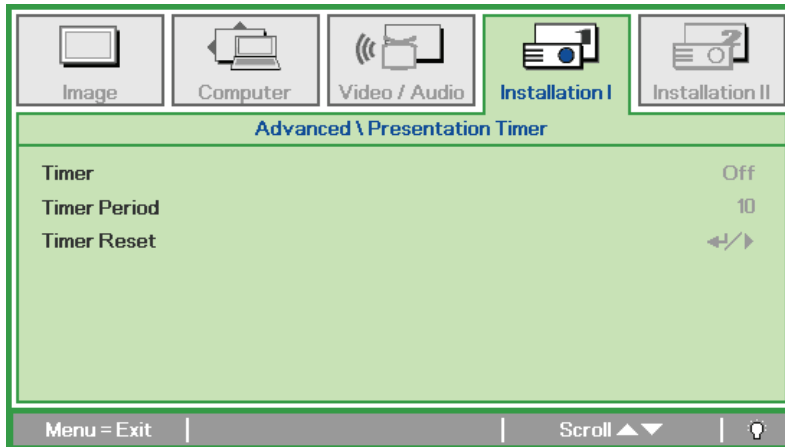

ITEM	DESCRIPTION
Timer	Press the cursor ◀▶ button to enable or disable presentation timer function.
Timer Period	Press the cursor ◀▶ button to adjust the display timer period.
Timer Reset	Press ◀ (Enter) / ▶ to reset presentation timer counter.

Installation II Menu

Press the **MENU** button to open the **OSD** menu. Press the cursor **◀▶** button to move to the **Installation II** menu. Press the cursor **▲▼** button to move up and down in the Installation II menu.

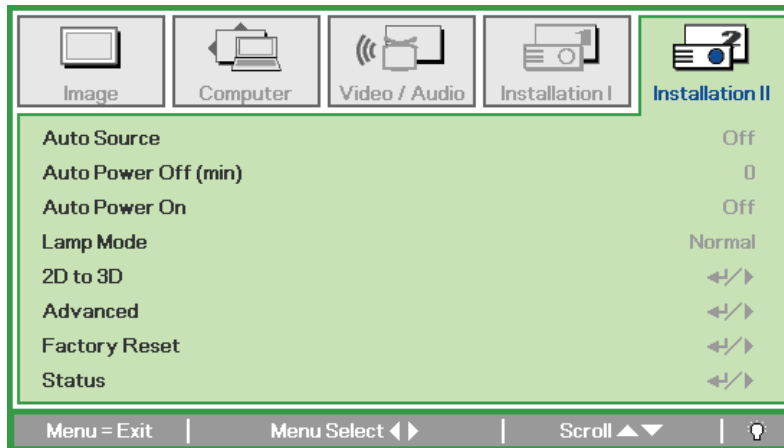

ITEM	DESCRIPTION
Auto Source	Press the cursor ◀▶ button to enable or disable automatic source detection.
Auto Power Off (min.)	Press the cursor ◀▶ button to enable or disable automatic shutdown of lamp when no signal.
Auto Power On	Press the cursor ◀▶ button to enable or disable automatic power On when AC power is supplied.
Lamp Mode	Press the cursor ◀▶ button to select the lamp mode for higher brightness or lower brightness to save lamp life.
2D to 3D	Press ↵ (Enter) / ▶ to enter the 2D to 3D menu. See <i>2D to 3D</i> on page 31.
Advanced	Press ↵ (Enter) / ▶ to enter the Advanced menu. See <i>Advanced Feature</i> on page 32.
Factory Reset	Press ↵ (Enter) / ▶ to reset all items to factory preset values.
Status	Press ↵ (Enter) / ▶ to enter the Status menu. See page 35 for more information on <i>Status</i> .

2D to 3D

Press the **Menu** button to open the **OSD** menu. Press ◀▶ to move to the **Installation II** menu. Press ▲▼ to move to the **2D to 3D** menu and then press **Enter** or ▶. Press ▲▼ to move up and down in the **2D to 3D** menu. Press ◀▶ to change values for setting.

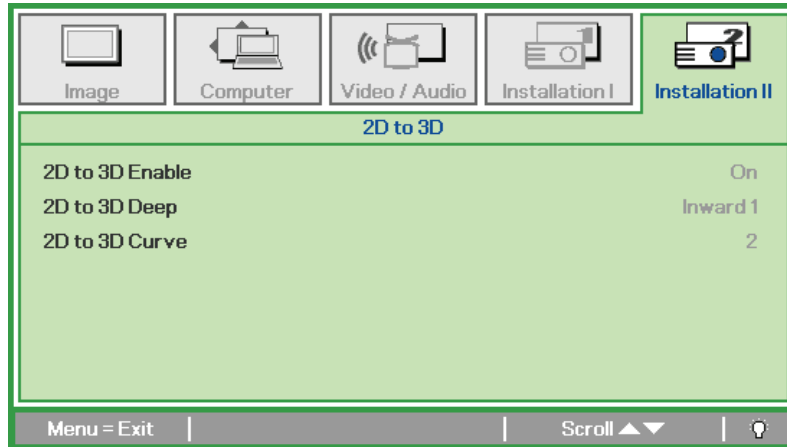

ITEM	DESCRIPTION
2D to 3D Enable	Press ◀▶ to disable or enable different 2D to 3D Enable mode.
2D to 3D Deep	Press ◀▶ to disable or enable different 2D to 3D Deep mode.
2D to 3D Curve	Press ◀▶ to disable or enable different 2D to 3D Curve mode.

Note:

- . Available only for HDMI source with 2D content (signals)
- . For use with **DLP 3D glasses**.
- . Maximum resolution of 720P.
- . 3D shutter glasses need to support 96Hz if input signal is Blue-ray 3D 1080p 24Hz.

Advanced Feature

Press the **Menu** button to open the **OSD** menu. Press ◀▶ to move to the **Installation II** menu. Press ▲▼ to move to the **Advanced** menu and then press **Enter** or ▶. Press ▲▼ to move up and down in the **Advanced** menu. Press ◀▶ to change values for setting.

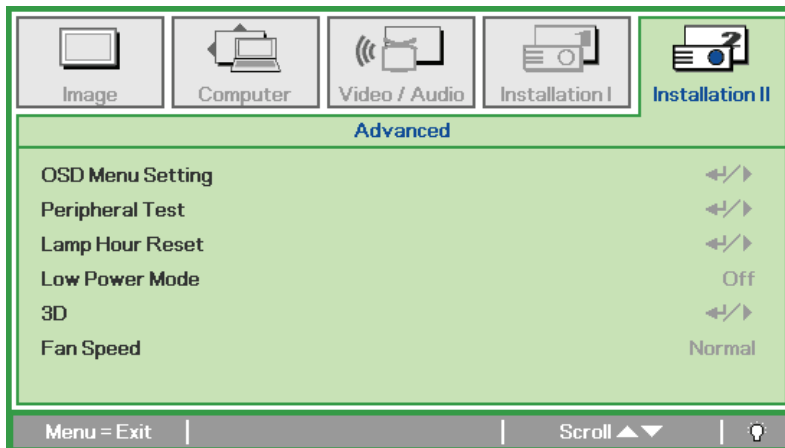

ITEM	DESCRIPTION
OSD Menu Setting	Press Enter / ▶ to enter the OSD setting menu. See page 33 for more information on <i>OSD Menu Setting</i> .
Peripheral Test	Press Enter/ ▶ to enter the Peripheral Test menu. See page 33 for more information on <i>Peripheral Test</i> .
Lamp Hour Reset	After replacing the lamp, this item should be reset. See page 34 for more information on <i>Lamp Hour Reset</i> .
Low Power Mode	Press ◀▶ to turn Low Power Mode on or off.
3D	Press ◀ (Enter) / ▶ to enter the 3D menu. See <i>3D</i> on page 31.
Fan Speed	Press the cursor ◀▶ button to toggle between Normal and High fan speeds. Note: We recommend selecting high speed in high temperatures, high humidity, or high altitude areas.

Note:

To enjoy the 3D function, first enable the Play Movie in 3D setting found in your DVD device under the 3D Disc Menu.

3D shutter glasses need to support 96Hz if input signal is Blue-ray 3D 1080p 24Hz.

OSD Menu Setting

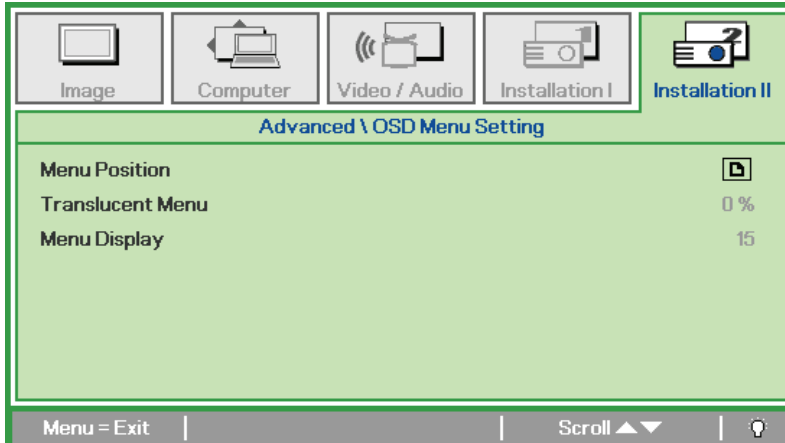

ITEM	DESCRIPTION
Menu Position	Press ◀▶ button to select different OSD location.
Translucent Menu	Press ◀▶ button to select OSD background translucent level.
Menu Display	Press ◀▶ button to select OSD timeout delay.

Peripheral Test

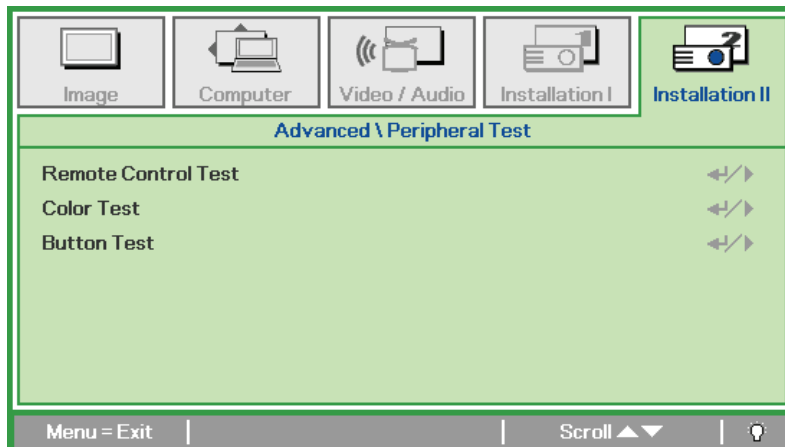

ITEM	DESCRIPTION
Remote Control Test	Press ◀ (Enter) / ▶ to test the IR remote controller for diagnostic.
Color Test	Press ◀ (Enter) / ▶ to select different colors on screen.
Button Test	Press ◀ (Enter) / ▶ to test the button on keypad.

Lamp Hour Reset

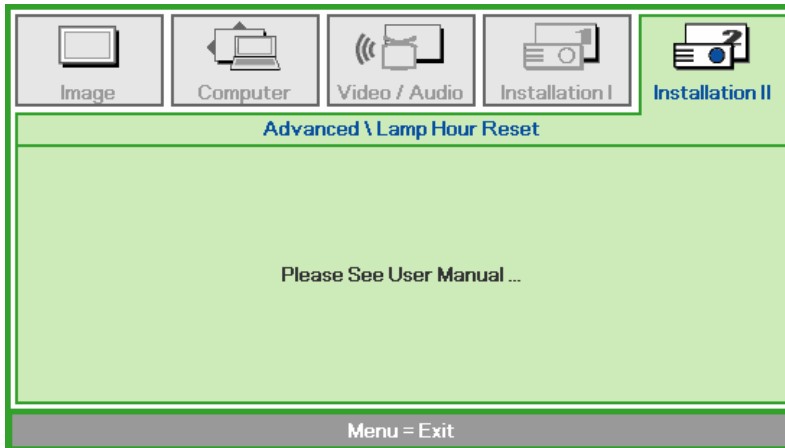

Please refer to *Resetting the Lamp* on page 38 to reset the lamp hour counter.

3D

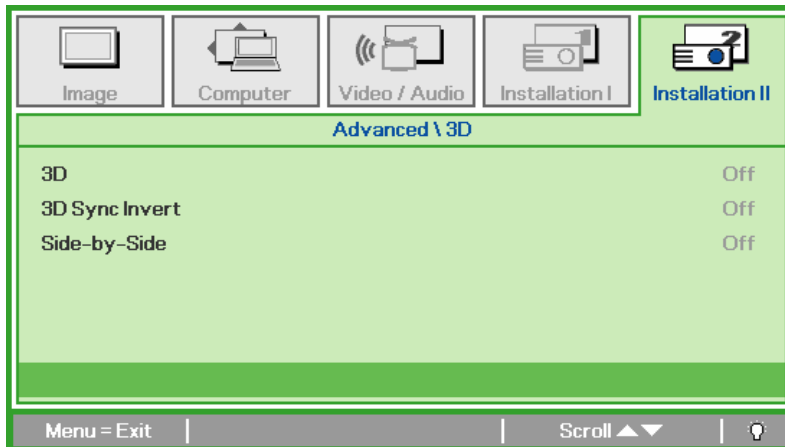

ITEM	DESCRIPTION
3D	Press ◀▶ to select Off, DLP-Link or IR.
3D Sync Invert	Press ◀▶ to turn 3D Sync Invert On or Off.
Side-by-Side	Press ◀▶ to turn Side-by-Side On or Off.

Factory Reset

Press the cursor ▲▼ button to move up and down in the **Installation II** menu. Select the **Factory Reset** sub menu and press ← (Enter) / ► to reset all the menu items to the factory default values (expect Language and Security Lock).

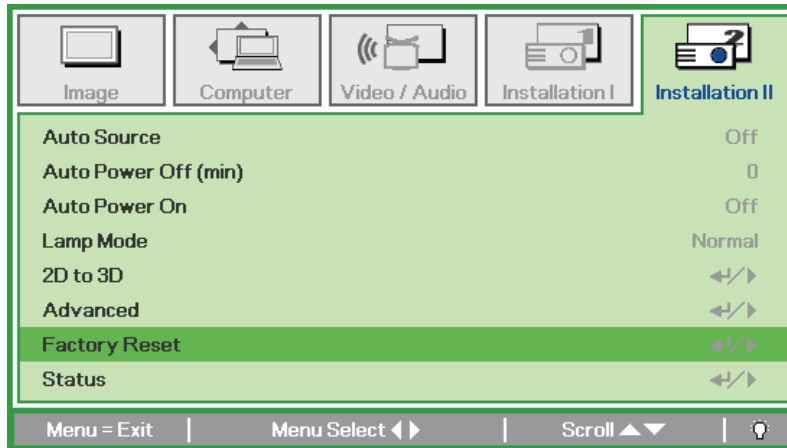

Status

Press the cursor ▲▼ button to move up and down in the **Installation II** menu. Select the **Installation II** sub menu and press ← (Enter) / ► to enter the **Status** sub menu.

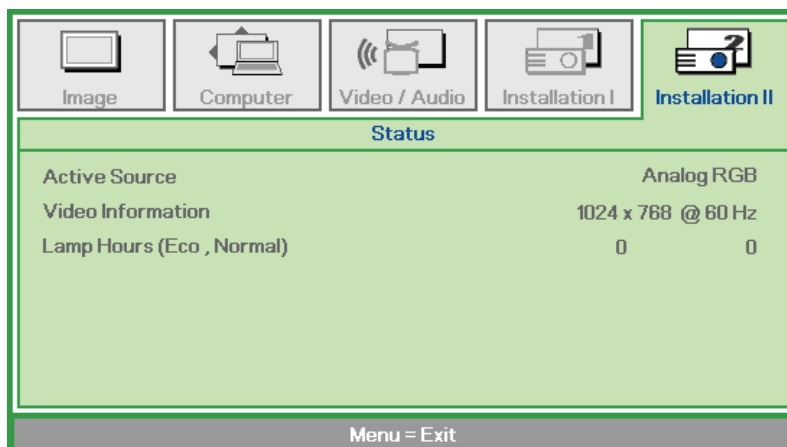

ITEM	DESCRIPTION
Active Source	Display the activated source.
Video Information	Displays resolution/video information for RGB source and color standard for Video source.
Lamp Hours	Lamp hour used information is displayed. Eco and Normal counters are separated.

MAINTENANCE AND SECURITY

Replacing the Projection Lamp

The projection lamp should be replaced when it burns out. It should only be replaced with a certified replacement part, which you can order from your local dealer.

Important:

- a. The projection lamp used in this product contains a small amount of mercury.
- b. Do not dispose this product with general household waste.
- c. Disposal of this product must be carried out in accordance with the regulations of your local authority.

Warning:

Be sure to turn off and unplug the projector at least 30 minutes before replacing the lamp. Failure to do so could result in a severe burn.

Caution:

In rare cases the lamp bulb may burn out during normal operation and cause glass dust or shards to be discharged outward from the rear exhaust vent.

Do not inhale or do not touch glass dust or shards. Doing so could result in injury.

Always keep your face away from the exhaust vent so that you do not suffer from the gas and broken shards of the lamp.



IF A LAMP EXPLODES

If a lamp explodes, the gas and broken shards may scatter inside the projector and they may come out of the exhaust vent. The gas contains toxic mercury.

Open windows and doors for ventilation.

If you inhale the gas or the shards of the broken lamp enter your eyes or mouth, consult the doctor immediately.

1. Loosen the captive screw on the lamp compartment cover.

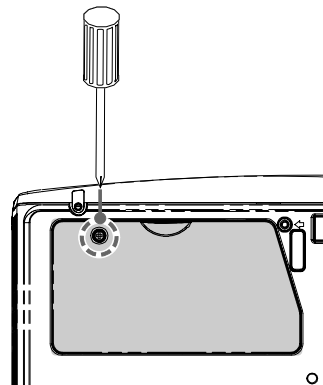

2. Remove the lamp compartment cover.

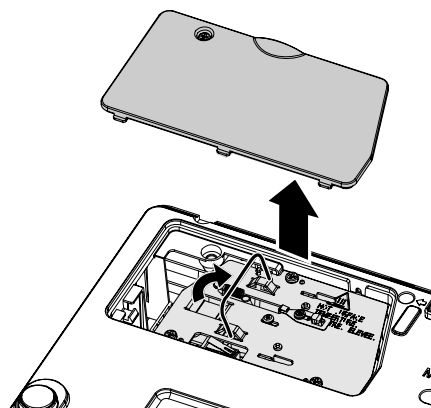

3. Remove the three screws from the lamp module.

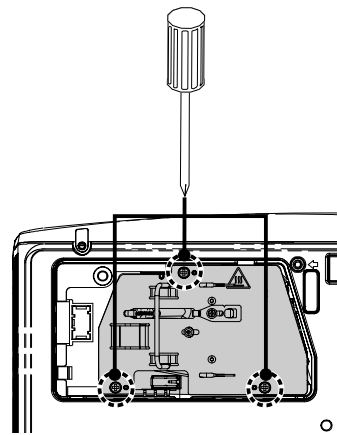

4. Lift the module handle up.

5. Disconnect the lamp connector.

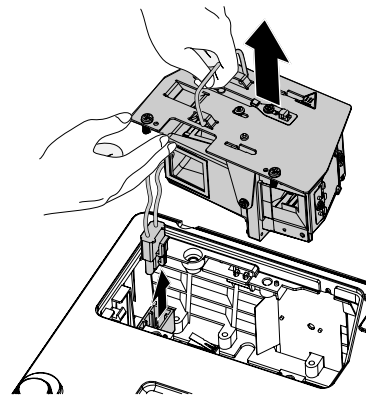

6. Pull firmly on the module handle to remove the lamp module.

7. Reverse steps 1 to 6 to install the new lamp module. While installing, align the lamp module with the connector and ensure it is level to avoid damage.

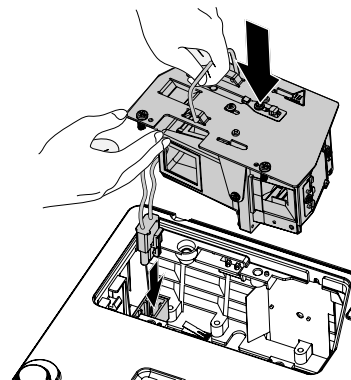

Note: The lamp module must sit securely in place and the lamp connector must be connected properly before tightening the screws.

Warning: Lamp Connector must be installed flush with the connector base as shown in the image below. A gap between the Lamp Connector and the connector base will cause damage to the projector. The following images illustrate correct and incorrect Lamp Connector installations.

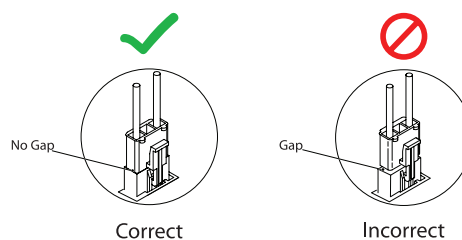

Resetting the Lamp

After replacing the lamp, you should reset the lamp hour counter to zero. Refer to the following:

1. Press the **MENU** button to open the OSD menu.
2. Press the cursor **◀▶** button to move to the **Installation II** menu. Press the cursor **▼▲** button to move down to **Advanced**.

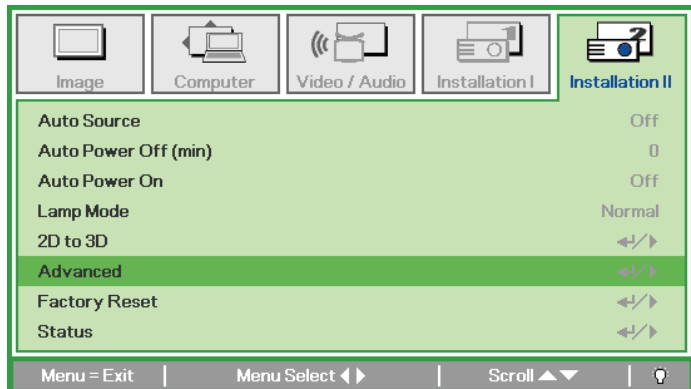

3. Press the cursor **▼▲** button to move down to **Lamp Hour Reset**.

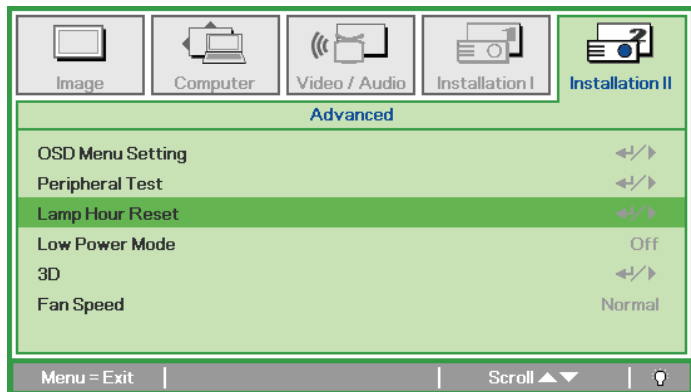

4. Press the cursor **▶** or Enter button.

A message screen appears.

5. Press **▼▲◀▶** buttons to reset the lamp hour.

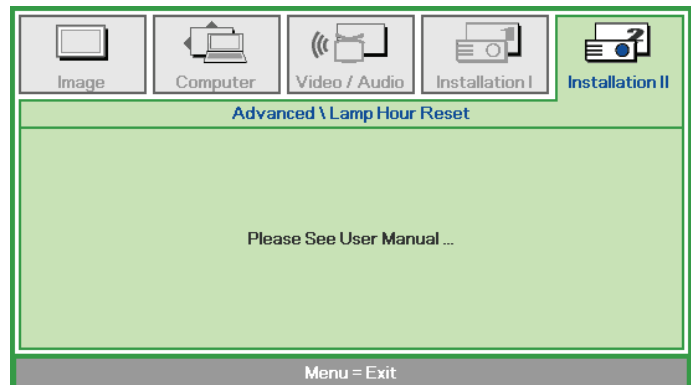

6. Press the **MENU** button to get back to Installation II.

Cleaning the Projector

Cleaning the projector to remove dust and grime will help ensure trouble-free operation.

Warning:

- 1. Be sure to turn off and unplug the projector at least 30 minutes before cleaning. Failure to do so could result in a severe burn.*
- 2. Use only a dampened cloth when cleaning. Do not allow water to enter the ventilation openings on the projector.*
- 3. If a little water gets into the projector interior while cleaning, leave unplugged in a well-ventilated room for several hours before using.*
- 4. If a lot of water gets into the projector interior when cleaning, have the projector serviced.*

Cleaning the Lens

You can purchase optic lens cleaner from most camera stores. Refer to the following to clean the projector lens.

1. Apply a little optic lens cleaner to a clean soft cloth. (Do not apply the cleaner directly to the lens.)
2. Lightly wipe the lens in a circular motion.

Caution:

- 1. Do not use abrasive cleaners or solvents.*
- 2. To prevent discoloration or fading, avoid getting cleaner on the projector case.*

Cleaning the Case

Refer to the following to clean the projector case.

1. Wipe off dust with a clean dampened cloth.
2. Moisten the cloth with warm water and mild detergent (such as used to wash dishes), and then wipe the case.
3. Rinse all detergent from the cloth and wipe the projector again.

Caution:

To prevent discoloration or fading of the case, do not use abrasive alcohol-based cleaners.

Using the Kensington® Lock

If you are concerned about security, attach the projector to a permanent object with the Kensington slot and a security cable.

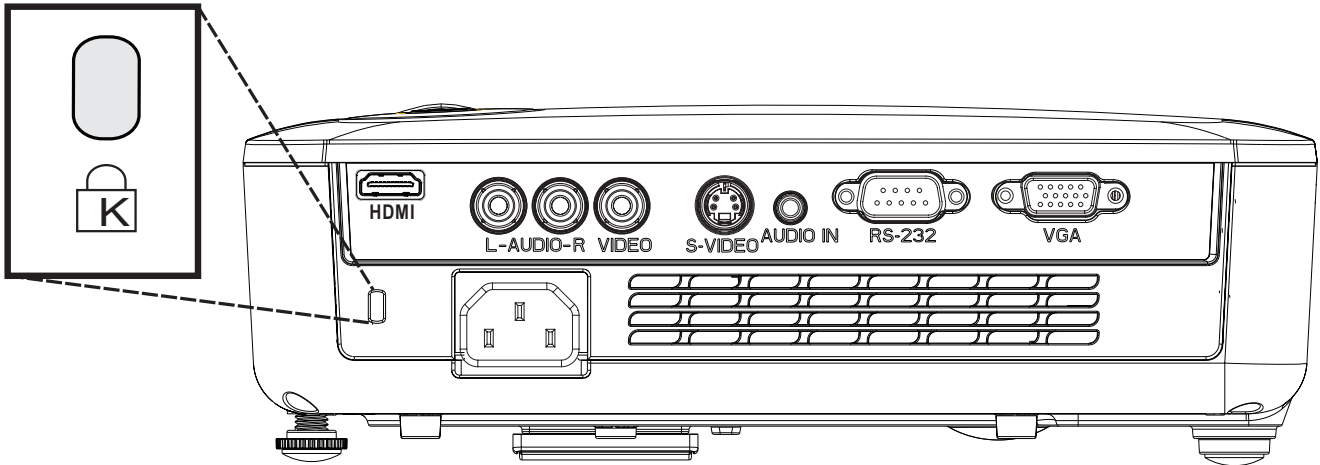

Note:

Contact your vendor for details on purchasing a suitable Kensington security cable.

The security lock corresponds to Kensington's MicroSaver Security System. If you have any comment, contact: Kensington, 2853 Campus Drive, San Mateo, CA 94403, U.S.A. Tel: 800-535-4242, <http://www.Kensington.com>.

TROUBLESHOOTING

Common problems and solutions

These guidelines provide tips to deal with problems you may encounter while using the projector. If the problem remains unsolved, contact your dealer for assistance.

Often after time spent troubleshooting, the problem is traced to something as simple as a loose connection. Check the following before proceeding to the problem-specific solutions.

- *Use some other electrical device to confirm that the electrical outlet is working.*
- *Ensure the projector is turned on.*
- *Ensure all connections are securely attached.*
- *Ensure the attached device is turned on.*
- *Ensure a connected PC is not in suspending mode.*
- *Ensure a connected notebook computer is configured for an external display. (This is usually done by pressing an Fn-key combination on the notebook.)*

Tips for Troubleshooting

In each problem-specific section, try the steps in the order suggested. This may help you to solve the problem more quickly.

Try to pin point the problem and thus avoid replacing non-defective parts.

For example, if you replace batteries and the problem remains, put the original batteries back and go to the next step.

Keep a record of the steps you take when troubleshooting: The information may be useful when calling for technical support or for passing on to service personnel.

LED Error Messages

ERROR CODE MESSAGES	POWER LED BLINK	OVER TEMP LED	LAMP LED BLINK
Over temperature	0	ON	0
Thermal break status error	4	0	0
Lamp error	0	0	On
Fan1 error	6	0	1
Fan2 error	6	0	2
Fan3 error	6	0	3
Lamp door open	7	0	0
DMD error	8	0	0
Color wheel error	9	0	0

In the event of an error, please disconnect the AC power cord and wait for one (1) minute before re-starting the projector. If the Power or Lamp LEDs are still blinking or the Over Temp LED is lit, or any other situation that isn't listed in the chart above, please contact your service center.

Image Problems

Problem: No image appears on the screen

1. Verify the settings on your notebook or desktop PC.
2. Turn off all equipment and power up again in the correct order.

Problem: The image is blurred

1. Adjust the **Focus** on the projector.
2. Press the **Auto** button on the remote control or projector.
3. Ensure the projector-to-screen distance is within the 10-meter (33-feet) specified range.
4. Check that the projector lens is clean.

Problem: The image is wider at the top or bottom (trapezoid effect)

1. Position the projector so it is as perpendicular to the screen as possible.
2. Use the **Keystone** button on the remote control or projector to correct the problem.

Problem: The image is reversed

Check the **Projection** setting on the **Installation I** menu of the OSD.

Problem: The image is streaked

1. Set the **Frequency** and **Tracking** settings on the **Computer** menu of the OSD to the default settings.
2. To ensure the problem is not caused by a connected PC's video card, connect to another computer.

Problem: The image is flat with no contrast

Adjust the **Contrast** setting on the **Image** menu of the OSD.

Problem: The color of the projected image does not match the source image.

Adjust the **Color Temperature** and **Gamma** settings on the **Image** menu of the OSD.

Lamp Problems

Problem: There is no light from the projector

1. Check that the power cable is securely connected.
2. Ensure the power source is good by testing with another electrical device.
3. Restart the projector in the correct order and check that the Power LED is green.
4. If you have replaced the lamp recently, try resetting the lamp connections.
5. Replace the lamp module.
6. Put the old lamp back in the projector and have the projector serviced.

Problem: The lamp goes off

1. Power surges can cause the lamp to turn off. Re-plug power cord. When the Power LED is on, press the power button.
2. Replace the lamp module.
3. Put the old lamp back in the projector and have the projector serviced.

Remote Control Problems

Problem: The projector does not respond to the remote control

1. Direct the remote control towards remote sensor on the projector.
2. Ensure the path between remote and sensor is not obstructed.
3. Turn off any fluorescent lights in the room.
4. Check the battery polarity.
5. Replace the batteries.
6. Turn off other Infrared-enabled devices in the vicinity.
7. Have the remote control serviced.

Audio Problems

Problem: There is no sound

1. Adjust the volume on the remote control.
2. Adjust the volume of the audio source.
3. Check the audio cable connection.
4. Test the source audio output with other speakers.
5. Have the projector serviced.

Problem: The sound is distorted

1. Check the audio cable connection.
2. Test the source audio output with other speakers.
3. Have the projector serviced.

Having the Projector Serviced

If you are unable to solve the problem, you should have the projector serviced. Pack the projector in the original carton. Include a description of the problem and a checklist of the steps you took when trying to fix the problem: The information may be useful to service personnel. For servicing, return the projector to the place you purchased it.

HDMI™ Q & A

Q. What is the difference between a “Standard” HDMI™ cable and a “High-Speed” HDMI™ cable?

Recently, HDMI™ Licensing, LLC announced that cables would be tested as Standard or High-Speed cables.

- Standard (or “category 1”) HDMI™ cables have been tested to perform at speeds of 75Mhz or up to 2.25Gbps, which is the equivalent of a 720p/1080i signal.
- High Speed (or “category 2”) HDMI™ cables have been tested to perform at speeds of 340Mhz or up to 10.2Gbps, which is the highest bandwidth currently available over an HDMI™ cable and can successfully handle 1080p signals including those at increased color depths and/or increased refresh rates from the Source. High-Speed cables are also able to accommodate higher resolution displays, such as WQXGA cinema monitors (resolution of 2560 x 1600).

Q. How do I run HDMI™ cables longer than 10 meters?

There are many HDMI™ Adopters working on HDMI™ solutions that extend a cable's effective distance from the typical 10 meter range to much longer lengths. These companies manufacture a variety of solutions that include active cables (active electronics built into cables that boost and extend the cable's signal), repeaters, amplifiers as well as CAT5/6 and fiber solutions.

Q. How can I tell if a cable is an HDMI™ certified cable?

All HDMI™ products are required to be certified by the manufacturer as part of the HDMI™ Compliance Test Specification. However, there may be instances where cables bearing the HDMI™ logo are available but have not been properly tested. HDMI™ Licensing, LLC actively investigates these instances to ensure that the HDMI™ trademark is properly used in the market. We recommend that consumers buy their cables from a reputable source and a company that is trusted.

For more detail information check <http://www.hdmi.org/learningcenter/faq.aspx#49>

SPECIFICATIONS

Specifications

Model	D512-3D	D536-3D	D538W-3D
Display type	TI DMD SVGA 0.55"	TI DMD XGA 0.55"	TI DMD WXGA 0.65"
Resolution	800x600 Native	1024x768 Native	1280x800 Native
Projection distance	1 - 10 m		1.27 - 10 m
Projection screen size	40" ~ 300"		
Projection lens	Manual Focus/Zoom		
Zoom ratio	1.1		1.15
Throw ratio	1.93 ~ 2.16		1.52 ~ 1.76
Vertical keystone correction	+/- 30 steps		
Projection methods	Front, Rear, Desktop/Ceiling (Rear, Front)		
Data compatibility	VGA, SVGA, XGA, SXGA, SXGA+, UXGA, Mac		
SDTV/EDTV/ HDTV	480i, 480p, 720p, 1080i, 1080p		
Video compatibility	NTSC/NTSC 4.43, PAL (B/G/H/I/M/N/60), SECAM		
H-Sync	15, 30 – 90 kHz		
V-Sync	43 – 85, 120 Hz		
Safety certification	FCC-B, cUL, UL, CE, C-tick, CCC, KC, CB, PCT, PSB, ICES-003, NOM		
Operation temperature	5° ~ 35°C		
Dimensions (WxHxD)	261.3 mm x 190.7 mm x 78 mm (10.33" x 7.8" x 3")		
AC Input	AC Universal 100 - 240, Typical @ 110VAC (100-240)/+10%		
Power consumption	Typical 230W (Normal) / Typical 205W (Eco)	Typical 300W (Normal) / Typical 230W (Eco)	
Stand By	<1 watts		
Lamp	180W (Normal) / 160W (Eco)	240W (Normal) / 180W (Eco)	
Audio speaker	2W mono speaker		
Input Terminals	VGA (15pin D-Sub) x 1		
	S-Video x 1		
	Composite Video x 1		
	HDMI™		
	RCA stereo x 1		
	Mini-jack stereo x 1		
Control Terminals	RS-232C		
Security	Kensington lock		

Note: For questions regarding product specifications, please contact your local distributor.

Projection Distance vs. Projection Size

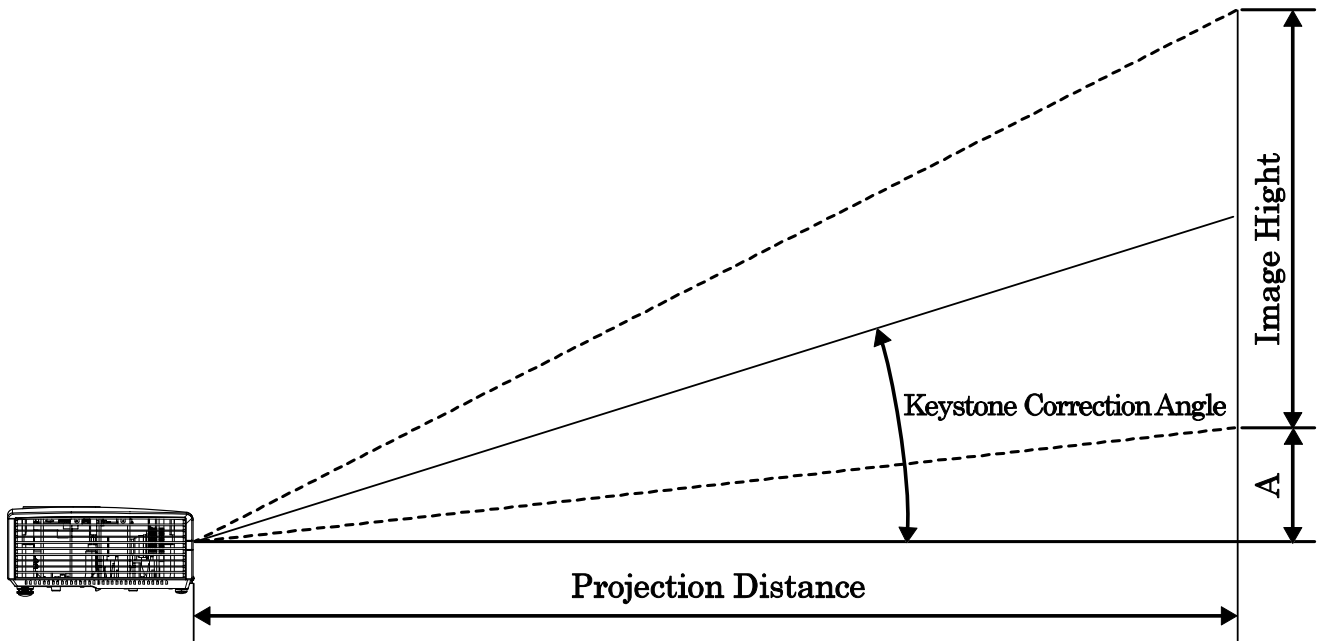

D5 Series Projection Distance and Size Table

D512-3D / D536-3D					
IMAGE DIAGONAL (INCH)	IMAGE WIDTH (INCH)	IMAGE HEIGHT (INCH)	PROJECTION DISTANCE (MM)		OFFSET-A (MM)
			FROM	TO	
40	32	24	1570	1730	85
60	48	36	2350	2600	128
70	56	42	2750	3030	149
72	56.7	43.2	2820	3120	154
80	64	48	3140	3460	171
84	67.2	50.4	3290	3640	179
90	72	54	3530	3900	192
96	76.8	57.6	3760	4160	205
100	80	60	3920	4330	213
120	96	72	4710	5190	256
135	108	81	5290	5840	288
150	120	90	5880	6490	320
200	160	120	7840	8660	427

D538W-3D					
IMAGE DIAGONAL (INCH)	IMAGE WIDTH (INCH)	IMAGE HIGHT (INCH)	PROJECTION DISTANCE (MM) <u>FROM</u>	PROJECTION DISTANCE (MM) <u>TO</u>	OFFSET-A (MM)
40	34	21	1310	1520	62
60	51	32	1960	2270	93
70	59	37	2290	2650	108
72	61	38	2360	2730	111
80	68	42	2620	3030	124
84	71	45	2750	3180	130
90	76	48	2950	3410	139
96	81	51	3140	3640	149
100	85	53	3270	3790	155
120	102	64	3930	4550	186
135	114	72	4420	5120	209
150	127	79	4910	5690	232
200	170	106	6550	7580	310

D5 Series Timing Mode Table

SIGNAL	RESOLUTION	H-SYNC (KHz)	V-SYNC (Hz)	COMPOSITE / S-VIDEO	COMPONENT	RGB	DVI/HDMI
NTSC	—	15.734	60.0	O	—	—	—
PAL/SECAM	—	15.625	50.0	O	—	—	—
VESA	720 x 400	37.9	85.0	—	—	O	O
	640 x 480	31.5	60.0	—	—	O	O
	640 x 480	37.9	72.0	—	—	O	O
	640 x 480	37.5	75.0	—	—	O	O
	640 x 480	43.3	85.0	—	—	O	O
	800 x 600	35.2	56.0	—	—	O	O
	800 x 600	37.9	60.0	—	—	O	O
	800 x 600	48.1	72.0	—	—	O	O
	800 x 600	46.9	75.0	—	—	O	O
	800 x 600	53.7	85.0	—	—	O	O
	1024 x 768	48.4	60.0	—	—	O	O
	1024 x 768	56.5	70.0	—	—	O	O
	1024 x 768	60.0	75.0	—	—	O	O
	1024 x 768	68.7	85.0	—	—	O	O
	1280 x 800	49.7	59.8	—	—	O	O
	1280 x 800	62.8	74.9	—	—	O	O
	1280 x 800	71.6	84.8	—	—	O	O
	1280 x 1024	63.98	60.0	—	—	O	O
	1280 x 1024	79.98	75.0	—	—	O	O
	1280 x 1024	91.10	85.0	—	—	O	O
	1280 x 960	60.0	60.0	—	—	O	O
	1280 x 960	85.9	85.0	—	—	O	O
	1400 x 1050	65.3	60.0	—	—	O	O
1440 x 900	70.6	75.0	—	—	O	O	
1440 x 900	55.6	60.0	—	—	O	O	

SIGNAL	RESOLUTION	H-SYNC (KHz)	V-SYNC (Hz)	COMPOSITE / S-VIDEO	COMPONENT	RGB	DVI/HDMI
	1600 x 1200	75.0	60.0	—	—	O	O
Apple Mac	640 x 480	35.0	66.68	—	—	O	O
	832 x 624	49.725	74.55	—	—	O	O
	1024 x 768	60.24	75.0	—	—	O	O
	1152 x 870	68.68	75.06	—	—	O	O
SDTV	480i	15.734	60.0	—	O	—	O
	576i	15.625	50.0	—	O	—	O
EDTV	480p	31.469	60.0	—	O	—	O
	576p	31.25	50.0	—	O	—	O
HDTV	720p	37.5	50.0	—	O	—	O
	720p	45.0	60.0	—	O	—	O
	1080i	33.8	60.0	—	O	—	O
	1080i	28.1	50.0	—	O	—	O
	1080p	67.5	60.0	—	O	—	O
	1080p	56.3	50.0	—	O	—	O

O: Frequency supported

—: Frequency not supported

*: Displayable level

Caution:

- . 3D maximum input timing is only support to 720P.
- . 2D to 3D maximum output timing is only support to 720P.

Projector Dimensions

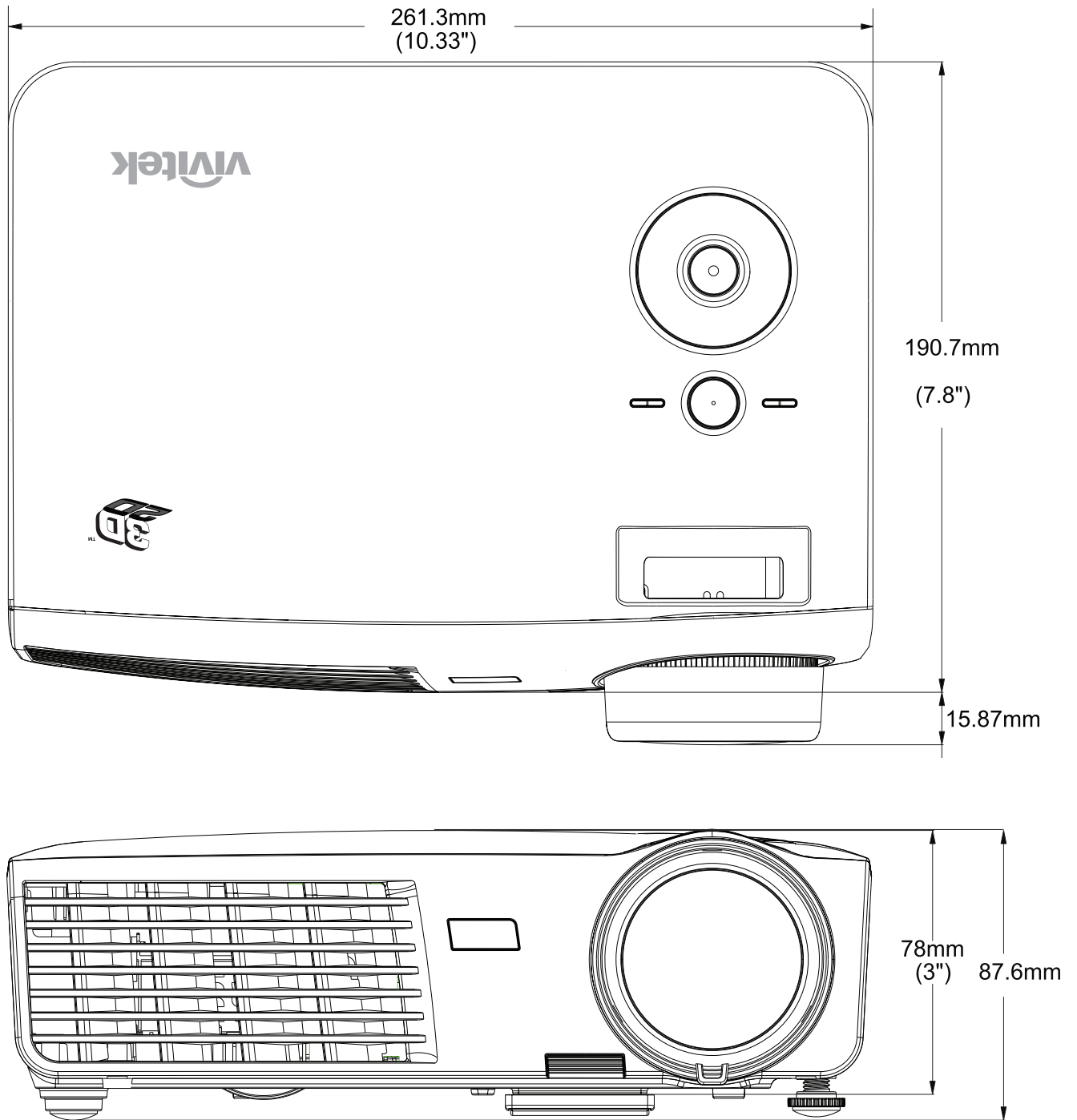

REGULATORY COMPLIANCE

FCC Warning

This equipment has been tested and found to comply with the limits for a Class B digital device pursuant to Part 15 of the FCC Rules. These limits are designed to provide reasonable protection against harmful interference when the equipment is operated in a commercial environment.

This equipment generates, uses, and can radiate radio frequency energy and, if not installed and used in accordance with the instruction manual, may cause harmful interference to radio communications. Operation of this equipment in a residential area is likely to cause harmful interference in which case the user will be required to correct the interference at his/her own expense.

Changes or modifications not expressly approved by the parties responsible for compliance could void the user’s authority to operate the equipment.

Canada

This class B digital apparatus complies with Canadian ICES-003.

Safety Certifications

FCC-B, UL, cUL, CB, CE, CCC, KC, PCT, PSB, NOM, ICES-003, and C-tick.

RS-232C Protocol

Note: Not all functions are available for all models due to different series.

RS232 Setting

Baud rate:	9600
Parity check:	None
Data bit:	8
Stop bit:	1
Flow Control	None

Minimum delay for next command: **1ms**

Control Command Structure

The command is structured by the Header code, command code, data code and end code. Most of the commands are structured except some for the compatibility issue with other projectors.

	Header code	Command code	Data code	End code
HEX	7Eh	Command	Data	0Dh
ASCII	'~'	Command	Data	CR

Control Sequence

The projector may send a return code after it received a command. If the command isn't received correctly, the projector will not send the return code

Operation Command

The operation commands execute the basic operation setting of this projector.

Operation	ASCII	HEX
Power On ※	~ P N CR ※	7Eh 50h 4Eh 0Dh
Power Off	~ P F CR	7Eh 50h 46h 0Dh
Auto Image	~ A I CR	7Eh 41h 49h 0Dh
Lamp Hour Reset	~ R L CR	7Eh 52h 4Ch 0Dh
Input Select RGB	~ S R CR	7Eh 53h 52h 0Dh
Input Select RGB2	~ S G CR	7Eh 53h 47h 0Dh
Input Select DVI	~ S D CR	7Eh 53h 44h 0Dh
Input Select Video	~ S V CR	7Eh 53h 56h 0Dh
Input Select S-Video	~ S S CR	7Eh 53h 53h 0Dh
Input Select Component	~ S Y CR	7Eh 53h 59h 0Dh
Input Select HDMI	~ S H CR	7Eh 53h 48h 0Dh
Input Select Wireless	~ S W CR	7Eh 53h 57h 0Dh

※ Power On command will only word at system standby.

※ CR: Carriage Return.

Remote Command

The remote commands simulate the code send from IR remote handset.

Button's name	ASCII	HEX
UP arrow	~ r U CR	7Eh 72h 55h 0Dh
DOWN arrow	~ r D CR	7Eh 72h 44h 0Dh
LEFT arrow	~ r L CR	7Eh 72h 4Ch 0Dh
RIGHT arrow	~ r R CR	7Eh 72h 52h 0Dh
POWER	~ r P CR	7Eh 72h 50h 0Dh
EXIT	~ r E CR	7Eh 72h 45h 0Dh
INPUT	~ r I CR	7Eh 72h 49h 0Dh
AUTO	~ r A CR	7Eh 72h 41h 0Dh
KEYSTONE+	~ r K CR	7Eh 72h 4Bh 0Dh
KEYSTONE-	~ r J CR	7Eh 72h 4Ah 0Dh
MENU	~ r M CR	7Eh 72h 4Dh 0Dh
STATUS	~ r S CR	7Eh 72h 53h 0Dh
MUTE	~ r T CR	7Eh 72h 54h 0Dh
ZOOM+	~ r Z CR	7Eh 72h 5Ah 0Dh
ZOOM-	~ r Y CR	7Eh 72h 59h 0Dh
BLANK	~ r B CR	7Eh 72h 42h 0Dh
FREEZE	~ r F CR	7Eh 72h 46h 0Dh
VOLUME+	~ r V CR	7Eh 72h 56h 0Dh
VOLUME-	~ r W CR	7Eh 72h 57h 0Dh
Enter	~ r N CR	7Eh 72h 4Eh 0Dh

Set Value Command

ITEM	ASCII	HEX
Brightness	~ s B ? CR ※	7Eh 73h 42h ?h 0Dh
Contrast	~ s C ? CR	7Eh 73h 43h ?h 0Dh
Color	~ s R ? CR	7Eh 73h 52h ?h 0Dh
Tint	~ s N ? CR	7Eh 73h 4Eh ?h 0Dh
Scaling	~ s A ? CR	7Eh 73h 41h ?h 0Dh
Color Temperature	~ s T ? CR	7Eh 73h 54h ?h 0Dh
Projection Mode	~ s J ? CR	7Eh 73h 4Ah ?h 0Dh

※ ? : ASCII Data

Data Range

ITEM	Set Data Range	Source
Brightness	0 ~ 100	ALL
Contrast	0 ~ 100	ALL
Color	0 ~ 100	Video/S-Video/Component
Tint	0 ~ 100	Video/S-Video/Component
Scaling	0: Fill 1: 4:3 2: 16:9 3 :Letter Box 4 :Native	ALL
Color Temperature	0: Cold 1: Normal 2: Warm	ALL
Projection Mode	0: Front 1: Rear 2: Rear+Ceiling 3: Ceiling	ALL

Attention: Data range may be different for different models

Example 1. Adjust Brightness value to 100

Send Command : ~sB100CR

Example 2. Adjust Color Temperature to Warm

Send Command : ~sT2CR

Query Command

ITEM	ASCII	HEX
Software Version	~qVCR	7Eh 71h 56h 0Dh
Power State	~qPCR	7Eh 71h 50h 0Dh
Input Select	~qSCR	7Eh 71h 53h 0Dh
Lamp Hours	~qLCR	7Eh 71h 4Ch 0Dh
Brightness	~qBCR	7Eh 71h 42h 0Dh
Contrast	~qCCR	7Eh 71h 43h 0Dh
Color (Video)	~qRCR	7Eh 71h 52h 0Dh
Tint (Video)	~qNCR	7Eh 71h 4Eh 0Dh
Scaling	~qACR	7Eh 71h 41h 0Dh
Color Temperature	~qTCR	7Eh 71h 54h 0Dh
Projection Mode	~qJCR	7Eh 71h 4Ah 0Dh

Response message

ITEM	Response Message examples
Software Version
Power State	On Off
Input Select	RGB RGB2 HDMI Video S- Video Component DVD HDTV
Lamp Hours	2000
Brightness	100
Contrast	100
Color (Video)	100
Tint (Video)	100
Scaling	Fill 4:3 16:9 LetterBox Native
Color Temperature	Cold Normal Warm
Projection Mode	Front Rear+Ceiling Rear Ceiling

Example 1. Get Brightness value

Send Command : ~qB`CR`

Response : 100

Example 2. Get Color Temperature

Send Command : ~qT`CR`

Response : Warm